

# STILLE Surgical Instruments



## Kirurgisk perfektion i över 175 år

I över 175 år har vi utvecklat och tillverkat de bästa kirurgiska instrumenten till världens mest krävande kirurger. Vi vill rikta ett stort tack till alla våra trogna kunder och samtidigt välkomna våra nya kunder. I den här katalogen presenterar vi vårt kompletta sortiment av STILLES original instrument.

Precision, hållbarhet och känsla är typiska egenskaper för alla STILLE-instrument. Den stora majoriteten är handgjorda av våra skickliga instrumentmakare Eskilstuna. Instrumentets resa från rundstål till ett färdigt instrument är lång, och består av många tillverkningssteg. STILLES unika tillverkningsmetod och användning av enbart det bästa materialet ger våra instrument deras unika känsla och hållbarhet.

I det första kapitlet hittar du våra saxar, allt från vanliga operationssaxar till våra unika SuperCut och Diamond SuperCut-saxar. Du hittar även STILLES pincetter, våra eleganta nålförare, peanger, klämmare, tänger, kyretter och hakar samt ett brett sortiment av mikroinstrument i både rostfritt stål och titan. Gemensamt för instrumenten är att de alla är smidiga med lätt gång. Deras balans, eleganta utformning och ergonomi möjliggör långa och komplicerade ingrepp med största säkerhet.

Fortfarande är vi mest stolta över att ha utvecklat världens första dubbelledade gougetång. Vi uppfann även världens första osteotom med det klassiska 8-kantiga handtaget. Båda har sedan dess kopierats många gånger, men en kopia kan aldrig mäta sig med originalet.

Kännetecknen för STILLES instrument är att de är lätta och gracila och fungerar perfekt under ingrepp som kräver extrem precision. Instrumenten blir en naturlig förlängning av kirurgens hand. Alltid med ett perfekt resultat.



## Surgical Perfection for over 175 years

For over 175 years, we have developed and manufactured the best surgical instruments for the world's most demanding surgeons. We would like to extend a heartfelt thank you to all our loyal customers and a warm welcome to our new customers. In this catalog we present our complete range of STILLE original surgical instruments.

Precision, durability and feel are characteristic qualities of all STILLE instruments. The vast majority are handcrafted by our highly skilled instrument makers in Eskilstuna, west of Stockholm, Sweden. The instruments' journey from a rod of stainless steel to a finished instrument is a long one, involving multiple stages. STILLE's unique method of crafting its instrument materials, and its usage of only the very highest-grade steels, give our instruments their unique feel and durability.

In the first chapter, you will find our line of scissors, everything from common surgical models to our unique original SuperCut and Diamond SuperCut scissors. You'll also find STILLE forceps, our elegant needle holders, artery forceps, clamps, rongeurs, curettes and retractors as well as a wide range of micro instruments made of stainless steel and titanium. Common to all of our instruments is that they are smooth and easy to operate. Their outstanding balance, elegant design and ergonomics allow long and complex procedures with the utmost security.

We are still proud to have developed the world's first double-action bone ronguer. We also invented the world's first osteotome with the classic 8-sided handle. Both instruments have since then been copied many times, but a copy can't measure up to the original.

STILLE instruments are known to be light and graceful and to function perfectly during procedures requiring extreme precision. The instruments become a natural extension of the surgeon's hand – and the result is always perfect.

# Innehåll | Table of contents | Inhaltsverzeichnis | Indice | Tabla de contenido | 目次

## 12 Saxar | Scissors | Scheren | Forbici | Tijeras | 剪刀 (はさみ)

- 16 Ögonsaxar | Eye Scissors | Augenscheren | Forbici oculistiche | Tijeras oculares | 眼科剪刀
- 17 Ögonlockssaxar | Blepharoplasty Scissors | Blepharoplastik-Scheren | Forbici per blefaroplastica | Tijeras de Blefaroplastia | 眼瞼形成用剪刀
- 18 Dissektionssaxar | Dissecting scissors | Präparierscheren | Forbici da dissezione | Tijeras para disección | 剥離・切離用剪刀
- 33 Operationsaxar | Operating scissors | Chirurgische Scheren | Forbici chirurgiche | Tijeras para cirugía | 外科剪刀
- 36 Tenotomisaxar | Tenotomy scissors | Sehenscheren | Forbici per tenotomia | Tijeras para tenotomia | 腱切除用剪刀
- 40 Kärlsaxar | Vascular scissors | Gefässcheren | Forbici vascolari | Tijeras vasculares | 血管剪刀
- 42 Nässaxar | Nasal scissors | Nasenscheren | Forbici nasali | Tijeras nasales | 鼻用剪刀
- 46 Face-lift saxar | Face-lift scissors | Face-lift Scheren | Forbici face-lift | Tijeras face-lift | フェイスリフト用剪刀
- 49 Trådföringssaxar | Suture carrying scissors | Fadenführungsscheren | Forbici portafilo | Tijeras portahilos | 縫合糸保持剪刀
- 50 Sutursaxar | Suture scissors | Fadenscheren | Cesoié per suture | Cizallas para suturas | 抜糸用剪刀

## 52 Pincetter | Forceps | Pinzetten | Pinze | Pinzas | 鑷子 (ピンセット)

- 54 Pincetter | Forceps | Pinzetten | Pinze | Pinzas | 鑷子 (ピンセット)
- 57 Anatomiska pincetter | Dressing forceps | Anatomische Pinzetten | Pinze anatomiche da dissezione | Pinzas de disección | 包帶鑷子
- 59 Durapincetter | Dura forceps | Durapinzetten | Pinze per dura madre | Pinzas para dura-madre | 硬膜鑷子または5爪鑷子
- 60 Irispincetter | Iris forceps | Irispinzetten | Pinze per iride | Pinzas para iris | 眼科鑷子
- 61 Kärlpincetter | Vascular forceps | Gefässpinzetten | Pinze vascolari | Pinzas vasculares | 血管鑷子
- 62 Diatermipincetter | Diathermy forceps | Diathermiepinzetten | Pinze per diatermia | Pinzas para diatermia | ジアテルミー鑷子
- 63 Knutpincetter | Knot-holding forceps | Knüpfpinzetten | Pinze per nodi | Pinzas para nudos | 結び目保持鑷子

## 64 Peanger | Artery forceps | Arterienklemmen | Pinze emostatiche | Pinzas hemostáticas | 止血鉗子

- 66 Peanger | Artery forceps | Arterienklemmen | Pinze emostatiche | Pinzas hemostáticas | 止血鉗子
- 78 Artär- och ligaturklämmare | Artery and ligature clamps | Arterien- und Ligaturklemmen | Pinzas per arterie e legature | Pinzas para arterias y ligaduras | 結紮鉗子および剥離鉗子

## 80 Nålförare | Needle holders | Nadelhalter | Portaghi | Porta-agujas | 持針器

- 82 **Nålförare storlekstabell** | Needle holder in relation to suture size | Nadelhalter in Relation zur Stärke des Nahtmaterials | Il portaaghi in relazione alla misura della sutura | Porta-agujas en relación al tamaño de la sutura | 縫合糸サイズに適する持針器
- 83 **Nålförare** | Needle holders | Nadelhalter | Portaghi | Porta-agujas | 持針器
- 92 **Knuthållartänger** | Knot-holding Forceps | Knüpfzangen | Pinze portanodi | Pinzas para atar nudos | 結び目保持鉗子
- 93 **Ståltrådsroterare & hållare** | Wire Twisting & Holding Forceps | Draht-Dreh- und Haltezange | Pinza serra-fili | Pinzas cierra-hilos y pinzas para extraer alambres | ワイヤークルマ

## 94 Bentänger | Bone cutters and rongeurs | Knochen & hohlmeisselzangen | Cesoié per ossa & pinze sgorbie | Pinzas cortantes & pinzas-gubias | 骨剪刀および骨鉗子(ロンジュール)

- 96 **Plattänger** | Flat pliers | Flachzangen | Tenaglia piatta | Alicates planos | ペンチ(シングルアクション)
- 97 **Extraktionstänger** | Extraction pliers | Extraktionszangen | Pinze d'estrazione | Pinzas de extracción | ペンチ(ダブルアクション)
- 98 **Benavbitare** | Bone cutting forceps | Knochensplitterzangen | Cesoié per ossa | Pinzas cortantes | 骨切り鉗子
- 100 **Gougetänger** | Bone rongeurs | Hohlmeisselzangen | Pinze-sgorbie | Pinzas-gubias | 骨鉗子(ロンジュール)
- 108 **Benhållartänger** | Bone holding forceps | Knochenhalte-zangen | Tenaglie per ossa | Pinzas para hueso | 骨保持鉗子
- 109 **Trådavbitare** | Wire cutters | Drahtkneifzangen | Tenaglie tagliafili | Alicates corta-alambres | ワイヤークッター
- 111 **Laminektomistansar** | Laminectomy punches | Laminektomiestanzen | Pinze taglienti per laminectomia | Pinzas cortantes para laminectomía | 椎弓切除用パンチ(ケリソパンチ)
- 113 **Bittänger** | Rongeurs for intervertebral discs | Bandscheiben-Rongeur | Pinze taglienti per dischi intervertebrali | Pinzas cortantes para discos intervertebrales | 骨鉗子(ボーンロンジュール)

## 116 Klämmare | Clamps | Klemmen | Pinze | Pinzas | 血管鉗子および組織把持鉗子

- 118 **Colonklämmare** | Colon Clamps | Colonklemmen | Pinze per colon | Pinzas para colon | 結腸鉗子
- 119 **Galltänger** | Gall duct clamps | Gallenkanalklemmen | Pinze per vie biliari | Pinzas para conductos biliares | 胆管クランプ
- 120 **Universalklämmare** | Multi-purpose clamps | Mehrzweckklemmen | Pinze per applicazione universale | Pinzas de múltiple uso | 多目的クランプ
- 123 **Tangential occlusionsklämmare** | Tangential occlusion clamps | Tangential-Verschlussklemmen | Pinze per occlusione tangenziale | Pinzas tangentes de oclusion | 正接鉗子
- 125 **Perifera kärlklämmare** | Peripheral vascular clamps | Peripheralklemmen | Pinze per vasi periferici | Pinzas para vaso periférico | 末梢血管クランプ
- 126 **Anastomosklämmare** | Anastomosis clamps | Anastomosenklemmen | Pinze per anastomosi | Pinzas para anastomosis | 吻合クランプ
- 127 **Aorta anastomosklämmare** | Aortic-anastomosis clamps | Aorten-Anastomosenklemmen | Pinze per anastomosi dell'aorta | Pinzas para anastomosis aórtica | 大動脈吻合クランプ

- 128 **Aorta-aneurysmklämmare** | Aortic-aneurysm clamps | Aorten-Aneurysmenklemmen | Pinze per aneurisme aortiche | Pinzas de aneurisma aórtica | 大動脈瘤クランプ
- 129 **Carotisklämmare** | Carotid clamps | Carotisklemmen | Pinze carotidee | Pinzas para carótida | 頸動脈クランプ
- 130 **Profunda arteria femoralis klämmare** | Profunda femoral artery clamps | Profunda Arteria Femoralis Klemmen | Pinze per arteria femorale profunda | Pinzas para arteria femoral profunda | 大腿深動脈クランプ
- 131 **Dukklämmare** | Towel clamps | Tuchklemmen | Fissatele | Pinzas de campo | タオル鉗子
- 132 **Fattningstånger** | Intestinal grasping forceps | Darmfasszangen | Pinze per afferrare l'intestino | Pinzas para coger intestinos | 腸管把持鉗子
- 135 **Ringtänger** | Sponge holding forceps | Schwammzangen | Pinze per spugne | Pinzas para esponjas | スポンジ鉗子
- 137 **Klotånger** | Tenaculum forceps | Hakenzangen | Pinze per il collo dell'utero | Pinzas para coger el cuello del útero | 子宮支持鉗子スポンジ鉗子

## 140

### Hakar | Retractors | Wundhaken | Divaricatori | Separadores | 開創器、鉤、レトラクター

- 142 **Hudhakar** | Skin hooks | Hauthäkchen | Uncini cutanei | Ganchos para piel | スキンフック
- 144 **Nervhakar** | Nerve hooks | Nervhäkchen | Uncini per nervi | Ganchos para nervios | 神経鉤
- 145 **Hakar** | Retractors | Wundhaken | Divaricatori | Separadores | 鉤(レトラクター)
- 151 **Bukhakar** | Abdominal retractors | Bauchdeckenhaken | Divaricatori addominali | Separadores abdominales | 開腹鉤
- 153 **Bukspatlar** | Abdominal spatulas | Bauchspatel | Spatole addominali | Espátulas abdominales | 腸ベラ
- 154 **Tracheotomihakar** | Trachea retractors | Trachealhaken | Divaricatori tracheali | Separadores para traquea | 気管支用レトラクター
- 155 **Självhållande hakar** | Self retaining retractors | Selbsthaltende Wundhaken | Autostatici divaricatori | Retención automática separadores | 開創器
- 157 **Revbensspridare** | Rib spreaders | Rippenspreizer | Divaricatori costali | Separadores costales | 開胸器
- 158 **Nässpekulum** | Nasal Specula | Nasenspekula | Speculi nasali | Espéculos nasales | 鼻鏡(スペキュラ)

## 160

### Slevar, Raspatorier, Elevatorier etc. | Curettes, Raspatories, Elevators etc. | Löffel, Raspatorien, Elevatorien etc. | Curette, Staccaperiostio, Elevatori etc. | Cucharillas, Legras, Elevadores etc. | 銳匙、やすり 骨膜起子

- 162 **Uteruskyretter** | Uterine curettes | Uterusküretten | Curette uterine | Curetas uterinas | 子宮銳匙
- 163 **Slevar** | Bone curettes | Löffel | Curette | Cucharillas | 骨銳匙
- 164 **Raspatorier** | Raspatories | Raspatorien | Staccaperiostio | Legras | 骨膜剝離子
- 169 **Elevatorier** | Elevators | Elevatorien | Elevatori | Elevadores | 骨膜起子
- 173 **Dissektorer** | Dissectors | Dissektoren | Dissettori | Disecadores | 剝離子
- 174 **Raspar** | Rasps | Raspeln | Raspe | Escofinas | 骨やすり

## 176 Osteotomer, mejslar etc. | Osteotomes, Chisels etc. | Osteotome, Flachmeissel etc. | Osteotomi, Scalpelli etc. | Escoplos, Cinceles etc. | 両刃のみ 片刃のみ

178 Osteotomer | Osteotomes | Osteotome | Osteotomi | Escoplos | 両刃のみ

185 Mejslar | Chisels | Flachmeissel | Scalpelli | Cinceles | 片刃のみ

186 Gougemejlar | Gouges | Gouges | Sgorbie | Gubias | 丸刃のみ

187 Prylar | Awls | Pfrieme | Lesine | Escariadores | 穿孔器

188 Hammare | Mallets | Hämmer | Martelli | Martillos | 槌

## 190 Mikroinstrument | Micro instruments | Mikro-instrumente | Strumenti per microchirurgia | Instrumentos para microcirugia | マイクロ器具

194 Mikrosaxar | Micro scissors | Mikroscheren | Mikro forbici | Micro tijeras | マイクロ剪刀

196 Mikropincetter | Micro forceps | Mikropinzetten | Micro pinze | Micro pinzas | マイクロ鑷子

200 Mikronålförare | Micro needle holders | Mikronadelhalter | Micro portaghi | Micro porta-agujas | マイクロ持針器

## 204 Övriga instrument | Various instruments | Sonstige Instrumente | Altri strumenti | Instrumentos varios | 様々な器具

206 Övriga instrument | Various instruments | Sonstige Instrumente | Altri strumenti | Instrumentos varios | 様々な器具

215 Implantat & instrument | Implants & instruments | Implantate & Instrumente | Implantati & strumenti | Implantés & instrumentos | インプラントおよび器具

## 217 Register | Index | Verzeichnis | Indice | Índice | 索引

217 Numeriskt index | Numerical index | Nummernverzeichnis | Indice di numeri | Indice de números | 品番索

221 Alfabetiskt register | Alphabetical index | Alphabetisches Inhaltsverzeichnis | Indice alfabetico | Índice alfabético | アルファベット索引

# Garanti

Med avseende på utförande och material lämnar vi garanti på kirurgiska handinstrument av egen tillverkning. I en period av 30 år efter inköp, ersätter eller reparerar vi kostnadsfritt ett skadat instrument om skadan finnes orsakad av fel i utförande eller material. Normal förslitning omfattas inte av vår garanti. Utfästelsen gäller under förutsättning att instrumentet används för avsett ändamål samt vårdas och lagras korrekt och att skriftlig anmälan görs till STILLE inom 30 dagar från skadetillfället.

# Guarantee

Surgical hand instruments manufactured by STILLE carry a guarantee in respect of materials and workmanship. For a period of 30 years after purchase, we will replace or repair a damaged instrument free of charge if the damage is found to have been caused by a defect in materials or workmanship. The guarantee is conditional on the instrument being used for the purpose intended, is cared for and stored correctly and that any claims are made in writing within 30 days of the damage occurring.



# Historien

När Sverige med Serafimerlasarettet fick sitt första undervisningssjukhus 1752 tog den medicinska vården ett stort steg framåt. Men hundra år senare fanns det fortfarande inte fler än 200 kirurger i hela landet. Med inrättandet av Karolinska institutet 1810 förenades de två grenarna medicin och kirurgi och studenter utbildades nu i både invärtes och utvärtes sjukdomar. Dessutom anställde Karolinska institutet en instrumentmakare som utöver tillverkning även gav utbildning i instrumentvård.

Det var den verksamheten på Karolinska institutet som Albert Stille tog över 1841 när han startade sitt företag. Redan från början förde han en intensiv dialog med läkare och kirurger. Ofta vände de sig direkt till honom och hans medarbetare med förslag och instrumentmakarna var alltid lika ivriga att förverkliga deras idéer. Den här nära relationen mellan ett medicintekniskt företag och olika medicinska institutioner var avgörande för den snabba utvecklingen inom medicin och kirurgi under 1800-talet.

De nyvunna kunskaperna inom mikrobiologi ledde till att man började sterilisera instrument, vilket minskade smittorisken för såväl patienter som kirurger och operationsassistenter. Och med viktiga upptäckter inom anestesi och antiseptisk sårbehandling vågade sig kirurgerna på allt djärvare ingrepp. Med hjälp av förfinade instrument skaffade de sig snabbt nya viktiga erfarenheter.

STILLE var först i världen med den tvådelade bentången redan 1872. Även andra produkter som revbenstången och gipssaxen gick hela tiden hand i hand med den snabba utvecklingen. Den nickelpläterade förlossningstången kom 1877. Ytan stod emot påverkan från blod och var lättare att rengöra. Förnicklade instrument blev därefter standard på marknaden tills STILLE 1923 introducerade världens första instrument i rostfritt stål. Och med SuperCut 1982 skapades en unik kvalitets sax som fortfarande söker sin like i världen.

Albert Stille valdes 1868 in som ledamot av Svenska läkaresällskapet. *"För hans förtjänster om den kirurgiska och obstetriska instrumenttillverkningen i vårt land och de flera lyckliga dels egna uppfinningar, dels förbättringar av förutvarande modeller"*. Så löd rekommendationen från professorer och kirurger vid Serafimerlasarettet och Karolinska institutet. Nio år senare valdes även sonen Max in som ledamot.

Albert och Max Stille delade en äkta, livslång passion för att utveckla kvalitetsinstrument. Mer än 175 år senare lever deras fasta övertygelse, starka framåtanda och förtroagna samarbete med läkare och kirurger fortfarande kvar hos STILLE.



Karolinska institutet och Serafimerlasarettet på 1860-talet.  
Karolinska Institute and Serafimer Hospital in the 1860's.



# History

When the Serafimer Hospital in Stockholm became Sweden's first teaching hospital in 1752, medical care in the country took a great step forward. But one hundred years later there were still no more than 200 practicing surgeons in the country. With the establishment of the Karolinska Institute in 1810, the two branches, medicine and surgery, were united and students were educated in both internal and external diseases. In addition, the Karolinska Institute commissioned an instrument maker that went beyond manufacturing but also provided training regarding instrument care.

It was this business at the Karolinska Institute that Albert Stille took over in 1841 when he started his company. From the outset, he maintained an intensive dialogue with physicians and surgeons. Often, they turned directly to him and his colleagues with suggestions, and the instrument makers were always eager to realize their ideas. This close relationship between a medical device company and various medical institutions was crucial to the rapid developments that occurred in medicine and surgery in the 1800's.

The newly gained knowledge in microbiology led to sterilization of instruments, which reduced the risk of infection for patients, surgeons and surgical assistants. And with important discoveries in anesthetics and antiseptic wound treatment, surgeons dared to undertake increasingly bold surgical procedures. With the help of sophisticated new instruments, surgeons rapidly acquired important new experience.

STILLE was the first in the world with the double-action bone rongeur as early as 1872. Other instruments like rib forceps and plaster scissors also contributed to the rapid development. The nickel-plated obstetrical forceps came in 1877. The surface was blood resistant and was easier to clean. Nickel-plated instruments became the market standard until 1923 when STILLE introduced the world's first stainless steel instruments. And

with the SuperCut in 1982, STILLE created a unique quality scissors that are still unmatched in the world.

In 1868 Albert Stille was elected as a member of the Swedish Society of Medicine. *"For his merits in the area of surgical and obstetrical instrument manufacturing in our country, and the success of their own inventions, and improvements to previous designs."* Those were the words at his induction from professors and surgeons at the Serafimer Hospital and the Karolinska Institute. Nine years later, his son Max was also voted in as a member.

Albert and Max Stille shared a genuine, lifelong passion for developing quality instruments. More than 175 years later, their firm convictions, strong ambitions and earnest collaboration with physicians and surgeons still live on with STILLE.

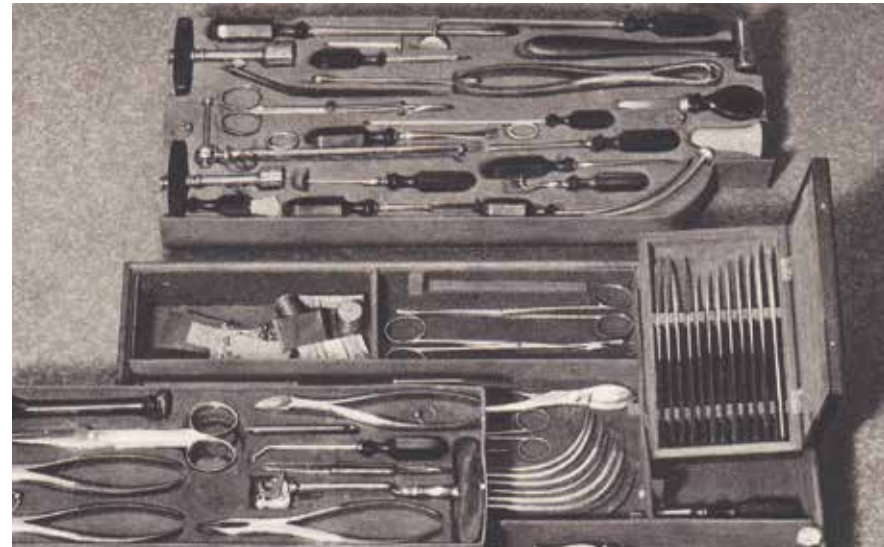

*Instrument för arméns sjukvård 1864.  
Instruments for the Army Medical Corps 1864.*

# Hantverk och service

Järnsmede med manufaktur av knivar, saxar, tänger och hammare har länge varit hjärtat i Eskilstunas industrihistoriska arv. STILLE är det enda medicintekniska företag i världen som fortfarande tillverkar instrument från rundstål i egen smedja. Än idag kan man höra hur hejarhammare slår ut det uppvärmda stålämnet, rikthammarnas lätta slag mot skänklar och käftar och filarnas torra raspande mot det ohärdade stålet.

För instrumentmakarna har tillverkningen alltid behållit sin hantverksmässiga karaktär. Här förlitar man sig inte enbart på ritningar utan precis lika mycket på den egna känslan för funktion och egenskaper. Ett färdigt instrument fungerar som modell. Måtten sitter redan i nävarna. Instrumentmakarna känner den exakta böjningen med fingrarna och vet hur ett perfekt instrument känns i handen. Minsta defekt märks direkt.

Den där speciella fingertoppskänslan för funktion och egenskaper delar instrumentmakaren med kirurgen. Genom åren har STILLE samarbetat med en lång rad välkända kirurger över hela världen. De har på olika sätt

medverkat vid konstruktion och vidareutveckling. Deras erfarenhet och uppfinningsrikedom har ytterligare förfinat instrumenten. Därför kan en lång rad välkända kirurgers namn läggas till STILLES eget i sortimentet.

Instrumentmakarens sista arbetsmoment är att sätta firmamärket på det färdiga instrumentet. Under mer än 175 år har det kommit att stå för ett gediget hantverk, suverän funktion och överlägsen kvalitet. Det har gjort STILLE till ett osvikligt kännetecken för de unika instrumentegenskaper som kirurger världen över efterfrågar.

Alla instrument som regelbundet servas av STILLES skickliga instrumentmakare omfattas av en exklusiv 30-årsgaranti. Under servicen plockas instrumenten isär och rengörs in i minsta detalj, rörliga delar justeras och smörjs, saxblad slipas, eggar vässas, ytor renoveras och putsas innan instrumenten till slut funktionstestas. Den här noggranna omsorgen förlänger instrumentets livslängd och ökar patientsäkerheten.



# Craftsmanship and Service

Iron working and the manufacture of knives, scissors, pliers and hammers have long been at the heart of the city of Eskilstuna's industrial heritage. STILLE is the only medical instrument maker in the world that still manufactures instruments from tubular steel in their own forge. Even today, one can hear the beat as the drop hammer flattens the heated steel slabs, the light blow of chasing hammers to the shanks and jaws, and the dry rasping of files against the unhardened steel.

For makers of precision surgical instruments, production has always maintained its artisanal character. They rely not only on drawings but, just as much, on their own sense of functionality and feature. A complete instrument works like a model. The dimensions are already in the hands. Instrument makers know the precise bend with their own fingers, and they know how a perfect instrument should feel in the human hand. Minimum defects are immediately evident.

Instrument makers share that special fingertip sense of functionality with the surgeon. Through the years, STILLE has collaborated with a long list of renowned surgeons the world over. They have contributed in various ways to the construction and further development. Their experience and ingenuity has helped to further refine surgical instruments. Therefore, many wellknown surgeons' names have been added to STILLE's wide range of instruments.

An instrument maker's final task is to put the company name on the finished instrument. For more than 175 years, it has come to stand for solid craftsmanship, superb performance and superior quality. This has made the STILLE name synonymous with the unique features and performance that surgeon's around the world demand.

All instruments that are regularly serviced by STILLE's skilled technicians are covered by an exclusive 30-year warranty. During the service process the instruments are disassembled and cleaned thoroughly, moving parts are adjusted and lubricated, scissor blades are sharpened, edges are honed, surfaces refinished and cleaned before the instruments undergo comprehensive testing. This meticulous maintenance prolongs the life of the instrument and increases patient safety.



**“SCISSORS, PLEASE!”** Kirurger över hela världen föredrar STILLES saxar. De är lätta och välbalanserade med en jämn, mjuk känsla som följer minsta rörelse så att saxen blir en naturlig förlängning av handen. Saxens utformning ger ett fast grepp med maximal klippförmåga för alla typer av mjuk vävnad. Oavsett modell är precisionen perfekt, hela vägen ut i spetsarna.

Sedan STILLE uppfann den första SuperCut-saxen redan 1982 har många försökt sig på att kopiera den. Men efter tre decennier kan fortfarande inget annat fabrikat mäta sig med denna handtillverkade supersax. En av de främsta egenskaperna är de specialdesignade skärytorna. Med ett saxslipat och ett knivslipat blad skär sig saxen mjukt och effektivt genom vävnaden. Snittet blir perfekt. Varje gång.

Saxsortimentet har utökats med ergonomiska saxar med vinklade skänklar för ett bekvämare grepp. Precis som alla andra saxar från STILLE är de högglanspolerade och kan vid service tas isär för enklare rengöring och sterilisering. Det ökar säkerheten för patient och kirurg samt förlänger instrumentets livstid. All service sköts av våra egna skickliga instrumentmakare. En sax från STILLE behåller sin höga kvalitet år efter år.



**“SCISSORS, PLEASE!”** Surgeons worldwide prefer scissors from STILLE. They are light and well-balanced with a smooth, soft feel that follows every movement so that the scissors become a natural extension of the hand. The scissor’s design provides a firm grip with maximum cutting power for all types of soft tissue. Regardless of the model they are perfectly precise – all the way to the tip.

Since STILLE invented the first SuperCut-scissors back in 1982, many have attempted to imitate the design. But after three decades no other brand can measure up to the handmade craftsmanship of the SuperCut. One of the main features is the specially designed cutting surfaces. With one scissor blade and one knife blade the scissors cut smoothly and efficiently through soft tissue. A perfect cut. Every time!

The product line has been expanded to include ergonomic scissors that feature angled handles for a more comfortable grip. Like all scissors from STILLE they are highly polished and can be disassembled for easy maintenance, cleaning and sterilization. This increases safety for the patient and the surgeon and extends the instrument’s effective lifetime. All service is handled by our own skilled craftsmen. A pair of scissors from STILLE retains their high quality year after year.

# Saxar | Scissors | Scheren | Forbici | Tijeras | 剪刀 (はさみ)

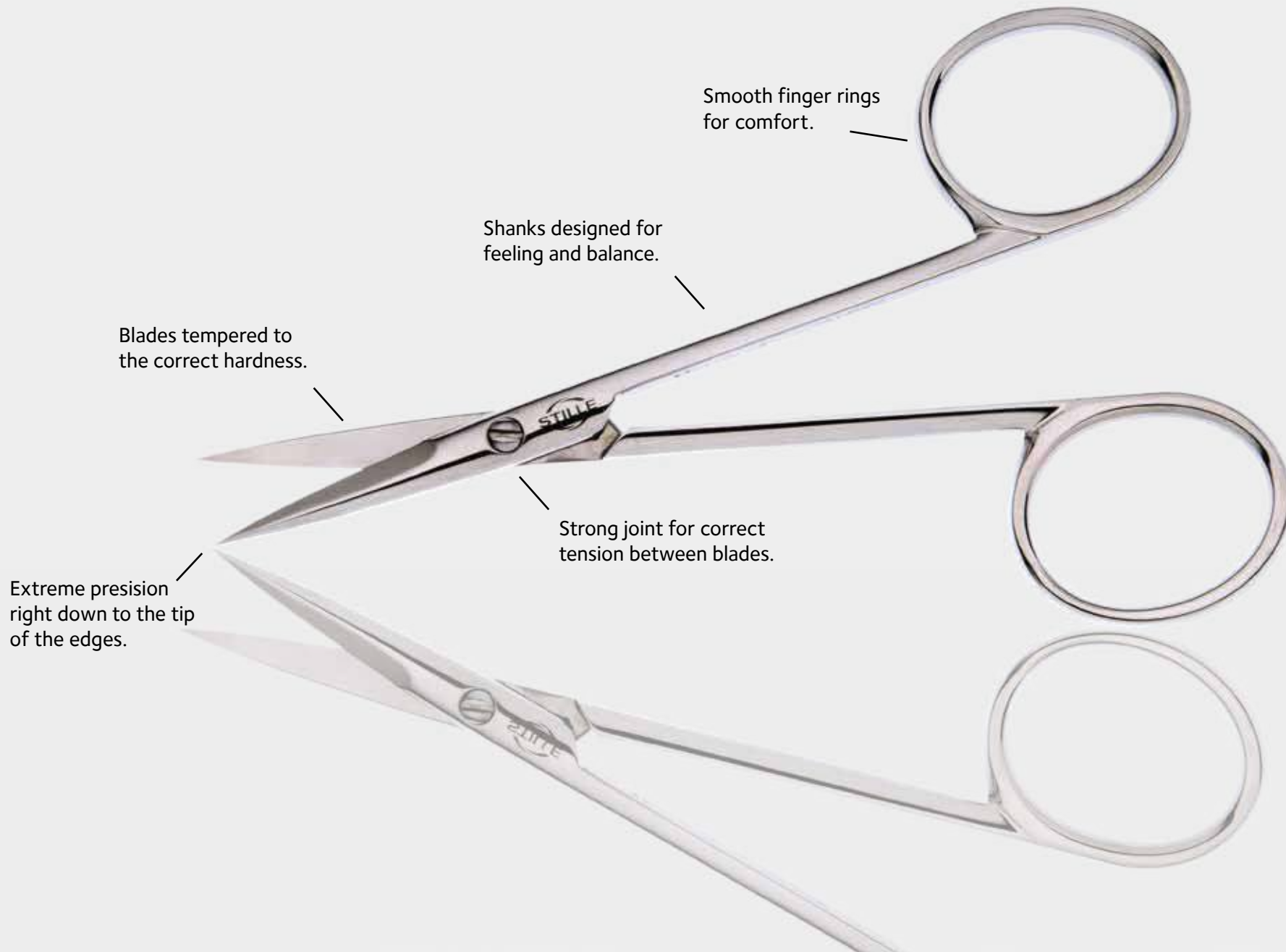

Smooth finger rings  
for comfort.

Shanks designed for  
feeling and balance.

Blades tempered to  
the correct hardness.

Strong joint for correct  
tension between blades.

Extreme precision  
right down to the tip  
of the edges.



STILLE Ögonsax | STILLE Eye Scissors

### ORIGINAL

Saxar har alltid tillhört STILLES storsäljare alltsedan de började tillverkas på 1800-talet. Genom åren har de ständigt förbättrats och fler specialmodeller har tillkommit. Idag finns de i totalt ca 200 varianter i alla storlekar och utformningar.

Originalsaxarna tillverkas i rostfritt stål av högsta kvalitet med höglanspolerad yta. De är välbalanserade med god skärstyrka ända ut i spetsarna och ligger bra i handen. Det finns originalsaxar för alla typer av mjukvävnad och de kan även användas för att klippa gasbinda, tråd och suturer.

### SUPERCUT

Saxarnas sax uppfanns 1982. Många kirurger anser att SuperCut är världens absolut bästa kirurgisax. Den passar alla typer av mjuk vävnad och precisionen och prestandan är välkänd bland kirurger över hela världen.

Det revolutionerande med SuperCut är skärytorna som samarbetar på ett unikt sätt. Det ena bladet är saxslipat och det andra är knivslipat så att saxen skär sig fram genom vävnaden. Det ger maximal skärstyrka med minimal kraft och ett perfekt snitt. Slipningen gör saxen lämplig för både höger- och vänsterhänta. Trots många år på marknaden har ingen lyckats skapa en kopia som kan överträffa originalet.

STILLES nya beläggning på SuperCut görs med ett mycket tunt diamantliknande skikt av s.k. DLC-coating, som reducerar risken för missfärgning, ökar instrumentets hållbarhet och bidrar till en bättre miljö.

### ORIGINAL

Scissors have always been STILLE's bestseller ever since they were first produced in the 1800's. Through the years they have been continually improved and more special models have been introduced. Currently, there are in total about 200 different varieties in all sizes and shapes.

Our original scissors are manufactured of the highest quality, polished stainless steel. They are well balanced with outstanding cutting power right down to the tips and they fit well in the surgeon's hand. There are original scissors for all types of soft tissue and they can also be used to cut gauze, wire and sutures.

### SUPERCUT

These unique scissors were introduced in 1982. Many surgeons believe that the SuperCut are unsurpassed as the world's best surgical scissors. They are suitable for all types of soft tissue and the precision and performance are well known among surgeons worldwide.

The revolutionary SuperCut scissors feature cutting surfaces that work together in a unique way. One blade is a scissor blade and the other is a knife blade to enable the scissors to cut precisely through the soft tissue. They provide maximum cutting power with minimal force and produce a perfect cut. The sharpening makes the scissors suitable for both right and left handed users. Despite many years on the market, other brands have not been able to create an imitation that can surpass the original SuperCut scissors.

The new STILLE coating process is based on a thin layer diamond-like-carbon proprietary technology, aiming to reduce discoloration, improve instrument durability and help to create a more sustainable environment.



STILLE-Mayo SuperCut XE dissektionsax |  
STILLE-Mayo SuperCut XE Dissecting Scissors

## DIAMOND SUPERCUT

Våra nya STILLE Diamond SuperCut saxar tar kirurgiska saxar till en ny nivå. Vi välkomnar er att uppleva dissektion, klippegenskaper och hållbarhet som ni aldrig tidigare upplevt. Diamond SuperCut är handgjorda av våra skickliga instrumentmakare i Eskilstuna. Saxarna är helbelagda med en ny diamantliknande beläggning, som ökar hållbarheten, minskar behovet av återkommande slipning, är mer motståndskraftig mot korrosion och är mer miljövänlig. Den nya Diamond-beläggningen är validerad för att tåla de allt vanligare rengöringsprocesserna med väteperoxid.



Metzenbaum STILLE Diamond SuperCut dissektionssax  
| Metzenbaum STILLE Diamond SuperCut Dissecting Scissors

## ERGONOMISKA SAXAR

En naturlig fortsättning på arbetet med att skapa perfekta saxar har varit att vidareutveckla deras ergonomiska egenskaper. Kirurgiska saxar hålls normalt i ett precisionsgrepp med tummen och lång- eller ringfingret. Vid mer tidskrävande ingrepp tröttnas handen ut snabbare.

Lösningen är att vinkla skänklarna så att handen kan arbeta närmare sitt normala viloläge. Med ett större mellanrum mellan fingeröglorna motverkas spänningar och trötthet och handen orkar arbeta längre. Samtliga ergonomiska saxar är av modellen SuperCut med sina unika egenskaper. Sax- och knivslipade blad samverkar för maximal skärstyrka med minimal kraft och exakt precision.

## DIAMOND SUPERCUT

The new STILLE Diamond SuperCut redefines the industry standards and breaks the limits in instrument performance. We welcome you to experience dissection, cutting performance and durability like you've never felt before. The Diamond SuperCut series of scissors are hand-made to perfection in Sweden. The scissors are fully coated with a new proprietary diamond-like-layer. It not only increases the life expectancy, it reduces the need of sharpening, is more resistant to corrosion and it's more environmental friendly. The new Diamond coating is validated to withstand the more common hydro peroxide processes.

## ERGONOMIC SCISSORS

A natural extension of the ongoing effort to create the perfect scissors has been the further development of their ergonomic properties. Surgical scissors are normally held in a precise grip using the thumb and middle or ring finger. For more time-consuming procedures this can cause the hand to become fatigued faster.

The solution is to angle the shanks so that the hand can work closer to its normal resting position. With a larger gap between the finger loops, tension and fatigue is countered and the hand can work more comfortably for a longer period. All ergonomic scissors are SuperCut models with their unique characteristics. Scissor and knife sharpened blades work together for maximum cutting power with minimal effort and exact precision.

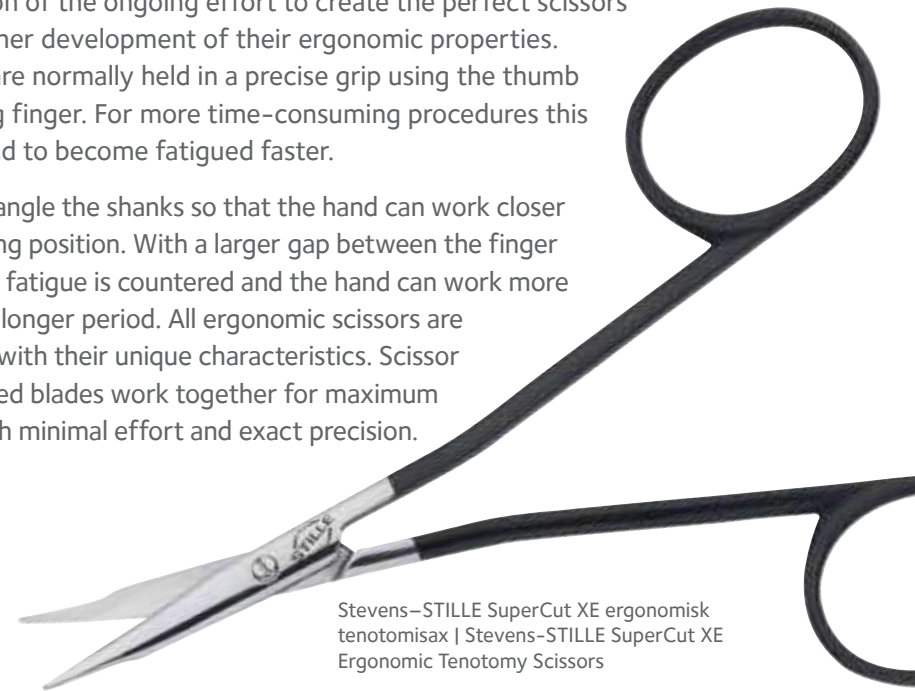

Stevens-STILLE SuperCut XE ergonomisk tenotomisax | Stevens-STILLE SuperCut XE Ergonomic Tenotomy Scissors

### STILLE ögonsax | STILLE Eye Scissors

Delicate eye scissors with sharp or blunt tips and large finger rings. These are also called iris scissors and are used for nerves, tendons and vessels. They are intended for facial surgery and any type of delicate surgery. Beveled blades.

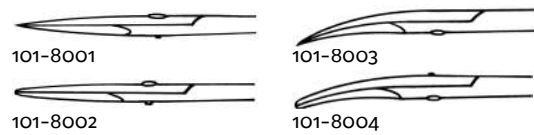
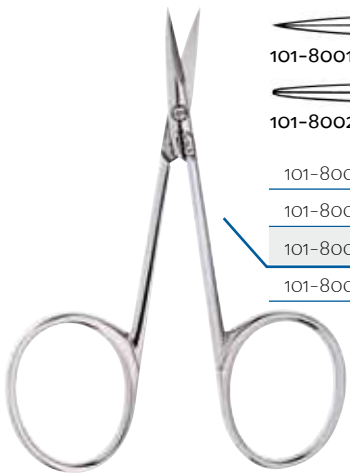

|          |          |       |              |
|----------|----------|-------|--------------|
| 101-8001 | Straight | Sharp | 9.5 cm 3.75" |
| 101-8002 | Straight | Blunt | 9.5 cm 3.75" |
| 101-8003 | Curved   | Sharp | 9.5 cm 3.75" |
| 101-8004 | Curved   | Blunt | 9.5 cm 3.75" |

### STILLE ögonsax | STILLE Eye Scissors

Eye scissors for delicate work. Large finger rings for a comfortable grip. Beveled blades.

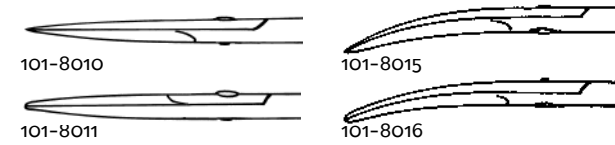
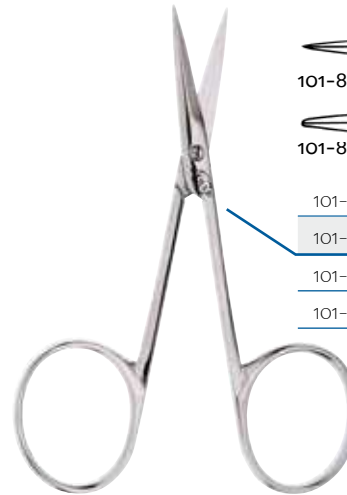

|          |          |       |          |
|----------|----------|-------|----------|
| 101-8010 | Straight | Sharp | 10 cm 4" |
| 101-8011 | Straight | Blunt | 10 cm 4" |
| 101-8015 | Curved   | Sharp | 10 cm 4" |
| 101-8016 | Curved   | Blunt | 10 cm 4" |

### STILLE SuperCut XE ögonsax | STILLE SuperCut XE Eye Scissors

SuperCut XE eye scissors with sharp or blunt tips and extremely sharp edges. Beveled blades.

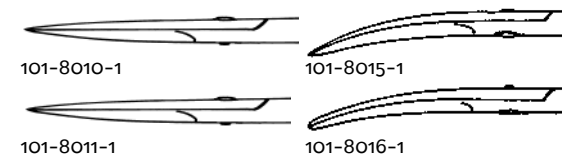

|            |          |       |          |
|------------|----------|-------|----------|
| 101-8010-1 | Straight | Sharp | 10 cm 4" |
| 101-8011-1 | Straight | Blunt | 10 cm 4" |
| 101-8015-1 | Curved   | Sharp | 10 cm 4" |
| 101-8016-1 | Curved   | Blunt | 10 cm 4" |



### STILLE SuperCut XE ögonlockssax | STILLE SuperCut XE Blepharoplasty Scissors

Short delicate SuperCut XE scissors suitable for blepharoplasty.

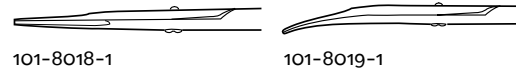

|            |          |              |
|------------|----------|--------------|
| 101-8018-1 | Straight | 9.5 cm 3.75" |
| 101-8019-1 | Curved   | 9.5 cm 3.75" |



### STILLE SuperCut XE ergonomisk ögonlockssax | STILLE SuperCut XE Ergonomic Blepharoplasty Scissors

Blepharoplasty SuperCut XE scissors with ergonomically designed shanks for a more relaxed grip.

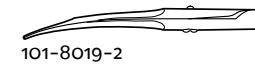

|            |        |              |
|------------|--------|--------------|
| 101-8019-2 | Curved | 9.5 cm 3.75" |
|------------|--------|--------------|

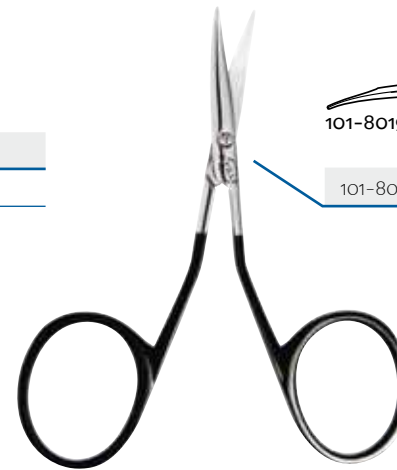

### Ragnell STILLE SuperCut XE ögonlockssax | Ragnell STILLE SuperCut XE Blepharoplasty Scissors

Short delicate SuperCut XE scissors with blunt, flat tips for blepharoplasty.

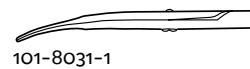

|            |        |              |
|------------|--------|--------------|
| 101-8031-1 | Curved | 9.5 cm 3.75" |
|------------|--------|--------------|

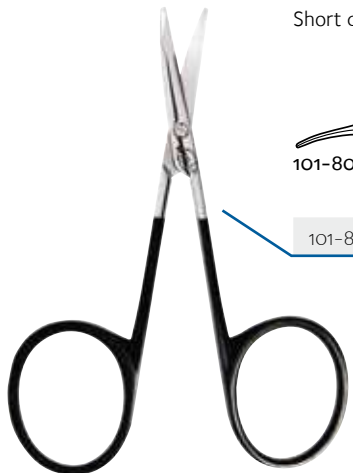

### Ragnell STILLE SuperCut XE ergonomisk ögonlockssax | Ragnell STILLE SuperCut XE Ergonomic Blepharoplasty Scissors

Blepharoplasty SuperCut XE scissors with ergonomically designed shanks for a more relaxed grip.



|            |        |              |
|------------|--------|--------------|
| 101-8031-2 | Curved | 9.5 cm 3.75" |
|------------|--------|--------------|

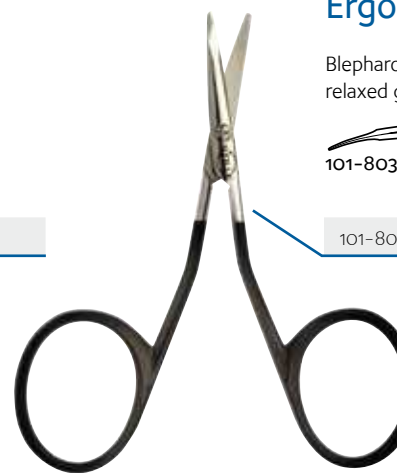

**Kaye STILLE dissektionssax |**  
**Kaye STILLE Dissecting Scissors**

Scissors with serrated blades for "holding" the tissue, making it easier to cut exactly as far as intended.



101-8020



101-8022



101-8021

|          |                |        |            |
|----------|----------------|--------|------------|
| 101-8020 | Blunt serrated | Curved | 10 cm 4"   |
| 101-8021 | Blunt serrated | Curved | 12.5 cm 5" |
| 101-8022 | Sharp serrated | Curved | 12.5 cm 5" |

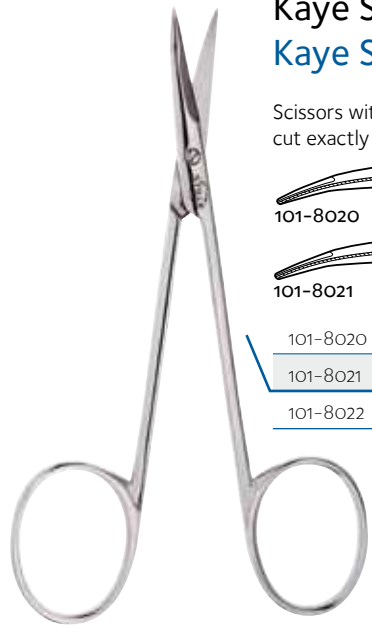

**Kaye STILLE SuperCut XE dissektionssax |**  
**Kaye STILLE SuperCut XE Dissecting Scissors**

SuperCut XE version for improved cutting performance.



101-8021-1

|            |                |        |            |
|------------|----------------|--------|------------|
| 101-8021-1 | Blunt serrated | Curved | 12.5 cm 5" |
|------------|----------------|--------|------------|



**Jabaley STILLE dissektionssax |**  
**Jabaley STILLE Dissecting Scissors**

Sharp scissors suitable for hand surgery, where very strong scissors are used. Beveled blades.



101-8060

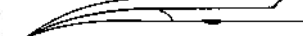

101-8062

|          |          |            |
|----------|----------|------------|
| 101-8060 | Straight | 12.5 cm 5" |
| 101-8062 | Curved   | 12.5 cm 5" |



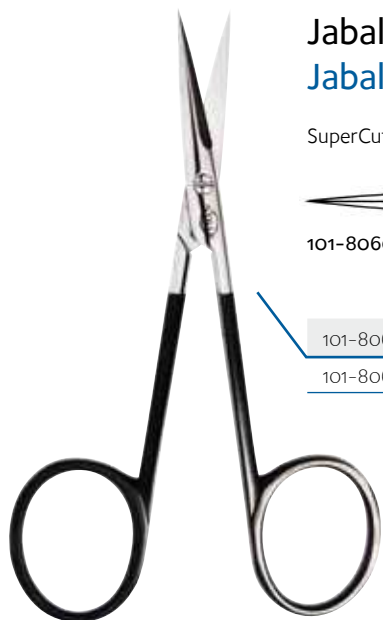

**Jabaley STILLE SuperCut XE dissektionssax | Jabaley STILLE SuperCut XE Dissecting Scissors**

SuperCut XE scissors for dissection of tough tissue in hand surgery. Beveled blades.

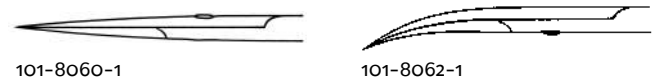

|            |          |            |
|------------|----------|------------|
| 101-8060-1 | Straight | 12.5 cm 5" |
| 101-8062-1 | Curved   | 12.5 cm 5" |

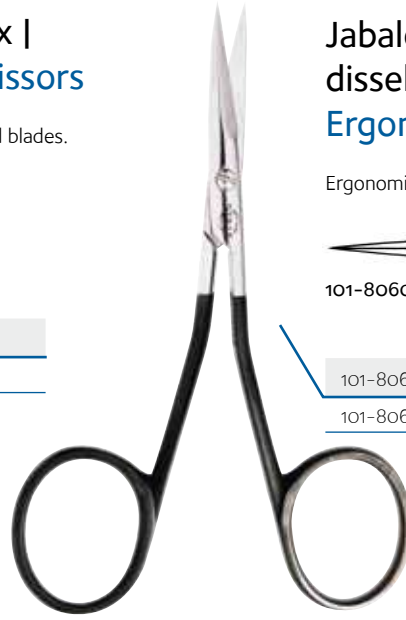

**Jabaley STILLE SuperCut XE ergonomisk dissektionssax | Jabaley STILLE SuperCut XE Ergonomic Dissecting Scissors**

Ergonomic model to avoid fatigue in the hand. Beveled blades.

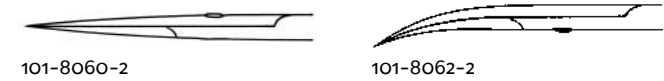

|            |          |            |
|------------|----------|------------|
| 101-8060-2 | Straight | 12.5 cm 5" |
| 101-8062-2 | Curved   | 12.5 cm 5" |



**Mayo STILLE dissektionssax | Mayo STILLE Dissecting Scissors**

The most used scissors, for all types of surgery. Used for routine dissection and cutting in tissue. Beveled blades.

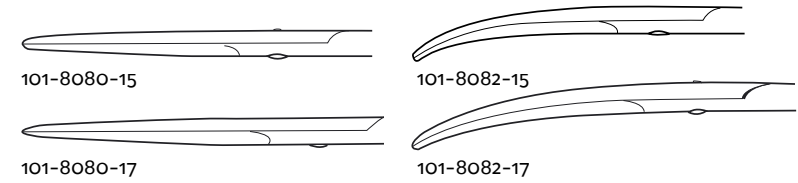

|             |          |             |
|-------------|----------|-------------|
| 101-8080-15 | Straight | 15 cm 6"    |
| 101-8080-17 | Straight | 17 cm 6.75" |
| 101-8082-15 | Curved   | 15 cm 6"    |
| 101-8082-17 | Curved   | 17 cm 6.75" |

**Mayo STILLE SuperCut XE dissektionssax | Mayo STILLE SuperCut XE Dissecting Scissors**

SuperCut XE dissecting scissors for tough tissue. Beveled blades.

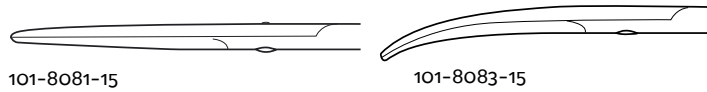

|             |          |          |
|-------------|----------|----------|
| 101-8081-15 | Straight | 15 cm 6" |
| 101-8083-15 | Curved   | 15 cm 6" |

**STILLE-Mayo dissektionssax | STILLE-Mayo Dissecting Scissors**

Sturdy dissecting scissors with rounded blades.

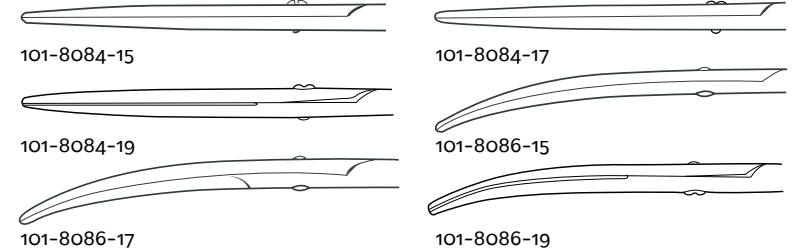
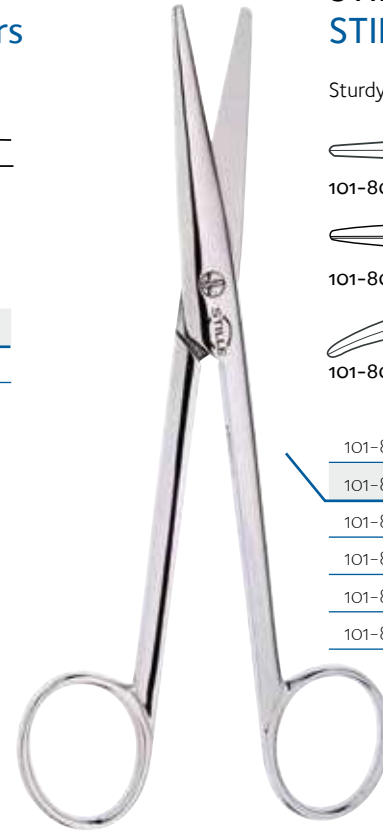

|             |                |          |             |
|-------------|----------------|----------|-------------|
| 101-8084-15 | Rounded blades | Straight | 15 cm 6"    |
| 101-8084-17 | Rounded blades | Straight | 17 cm 6.75" |
| 101-8084-19 | Rounded blades | Straight | 19 cm 7.5"  |
| 101-8086-15 | Rounded blades | Curved   | 15 cm 6"    |
| 101-8086-17 | Rounded blades | Curved   | 17 cm 6.75" |
| 101-8086-19 | Rounded blades | Curved   | 19 cm 7.5"  |

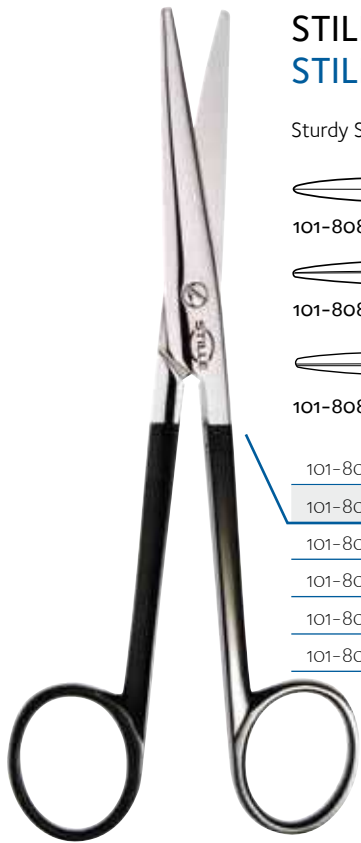

**STILLE-Mayo SuperCut XE dissektionssax | STILLE-Mayo SuperCut XE Dissecting Scissors**

Sturdy Super Cut scissors with rounded blades for dissection of tough tissue.

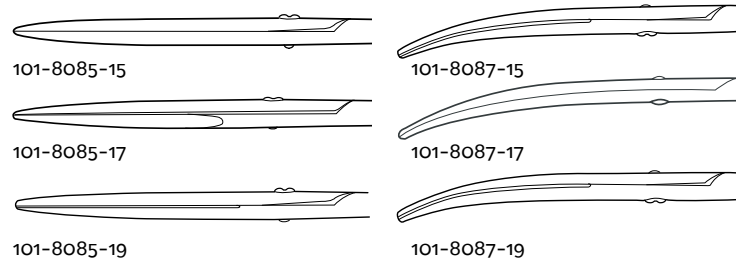

|             |                |          |             |
|-------------|----------------|----------|-------------|
| 101-8085-15 | Rounded blades | Straight | 15 cm 6"    |
| 101-8085-17 | Rounded blades | Straight | 17 cm 6.75" |
| 101-8085-19 | Rounded blades | Straight | 19 cm 7.5"  |
| 101-8087-15 | Rounded blades | Curved   | 15 cm 6"    |
| 101-8087-17 | Rounded blades | Curved   | 17 cm 6.75" |
| 101-8087-19 | Rounded blades | Curved   | 19 cm 7.5"  |

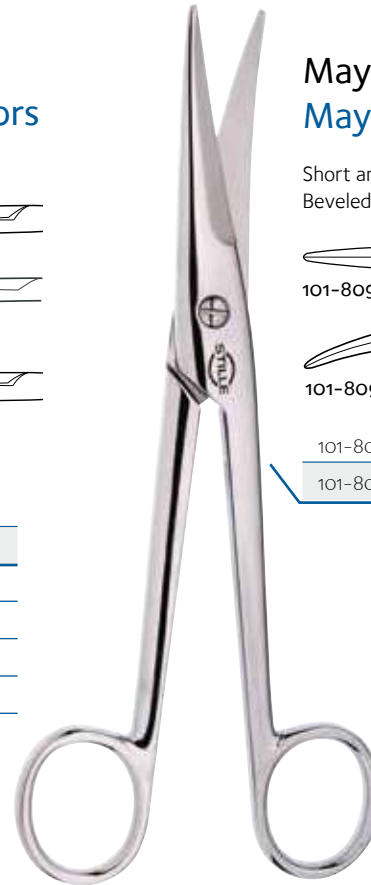

**Mayo-Noble STILLE dissektionssax | Mayo-Noble STILLE Dissecting Scissors**

Short and strong dissecting scissors mainly for orthopaedic surgeons. Beveled blades.

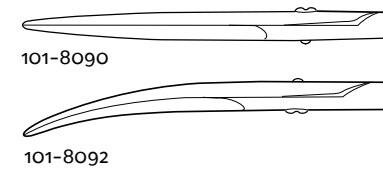

|          |          |          |
|----------|----------|----------|
| 101-8090 | Straight | 18 cm 7" |
| 101-8092 | Curved   | 18 cm 7" |

**Baby Mayo STILLE dissektionssax | Baby Mayo STILLE Dissecting Scissors**

Delicate version of the regular Mayo scissors. Mainly for plastic- and hand surgery. Beveled blades.

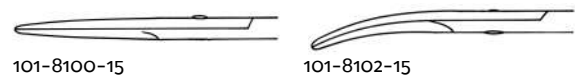

|             |          |          |
|-------------|----------|----------|
| 101-8100-15 | Straight | 15 cm 6" |
| 101-8102-15 | Curved   | 15 cm 6" |



**Sims STILLE dissektionssax |**  
**Sims STILLE Dissecting Scissors**

Mainly used in gynecological and other pelvic surgery. Beveled blades.

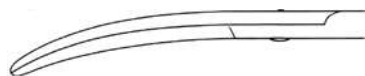

101-8138

|          |        |          |
|----------|--------|----------|
| 101-8138 | Curved | 20 cm 8" |
|----------|--------|----------|



**Baby Metzenbaum STILLE dissektionssax |**  
**Baby Metzenbaum STILLE Dissecting Scissors**

Short, delicate dissection scissors with rounded blades. Used in delicate surgery requiring small instruments.

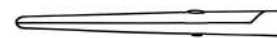

101-8160



101-8162

|          |          |            |
|----------|----------|------------|
| 101-8160 | Straight | 12.5 cm 5" |
| 101-8162 | Curved   | 12.5 cm 5" |

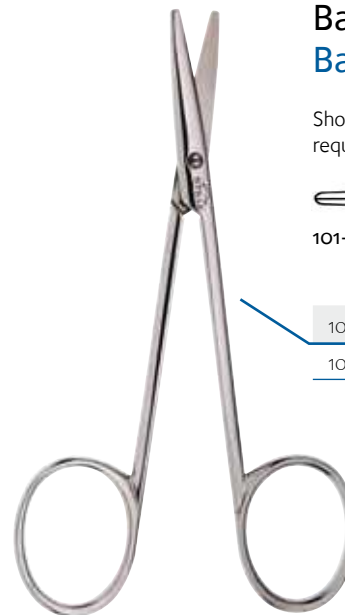

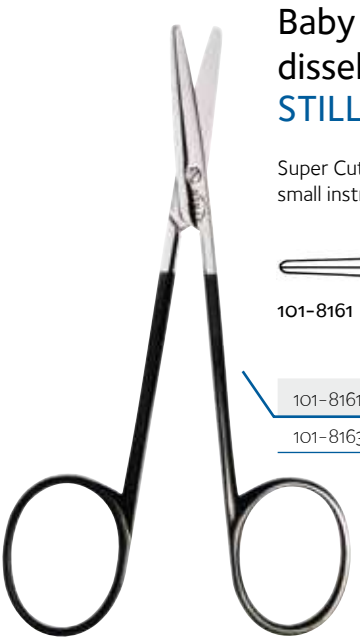

**Baby Metzenbaum STILLE SuperCut XE dissektionssax | Baby Metzenbaum STILLE SuperCut XE Dissecting Scissors**

Super Cut dissecting scissors for tough tissue. Used in delicate surgery requiring small instruments.

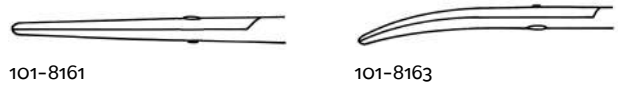

|          |          |            |
|----------|----------|------------|
| 101-8161 | Straight | 12.5 cm 5" |
| 101-8163 | Curved   | 12.5 cm 5" |



**Baby Metzenbaum STILLE Diamond SuperCut dissektionssax | Baby Metzenbaum STILLE Diamond SuperCut Dissecting Scissors**

With Diamond coating for increased durability.



|            |        |            |
|------------|--------|------------|
| 101-8163-C | Curved | 12.5 cm 5" |
|------------|--------|------------|



**Baby Metzenbaum STILLE SuperCut XE ergonomisk dissektionssax | Baby Metzenbaum STILLE SuperCut XE Ergonomic Dissecting Scissors**

Ergonomic model for better control. Rounded blades.



|            |        |            |
|------------|--------|------------|
| 101-8163-2 | Curved | 12.5 cm 5" |
|------------|--------|------------|

**Metzenbaum STILLE gracil dissektionssax | Metzenbaum STILLE Delicate Dissecting Scissors**

Short, delicate dissecting scissors with rounded blades. Used in delicate surgery requiring small instruments.



101-8172

101-8172-18 Curved delicate 18 cm 7"

101-8172-23 Curved delicate 23 cm 9"



**Metzenbaum STILLE gracil SuperCut XE dissektionssax | Metzenbaum STILLE Delicate SuperCut XE Dissecting Scissors**

Very delicate version with Super Cut edges and fine rounded tips.



101-8173-15



101-8173-18  
101-8173-20

101-8173-15 Curved delicate

15 cm 6"

101-8173-18 Curved delicate

18 cm 7"

101-8173-20 Curved delicate

20 cm 8"





**Metzenbaum STILLE gracil Diamond SuperCut dissektionssax | Metzenbaum STILLE Delicate Diamond SuperCut Dissecting Scissors**

With Diamond coating for increased durability.

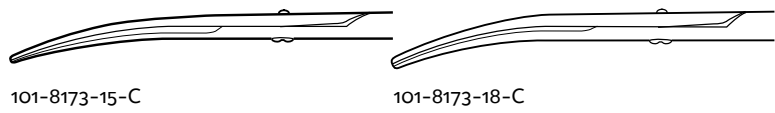

|               |                 |          |
|---------------|-----------------|----------|
| 101-8173-15-C | Curved delicate | 15 cm 6" |
| 101-8173-18-C | Curved delicate | 18 cm 7" |



**Metzenbaum STILLE dissektionssax | Metzenbaum STILLE Dissecting Scissors**

Dissecting scissors with rounded blades and tips. Used in all specialties for fine dissection. Metzenbaum is one of STILLE's most popular scissors model and is available in a variety of shapes and sizes.

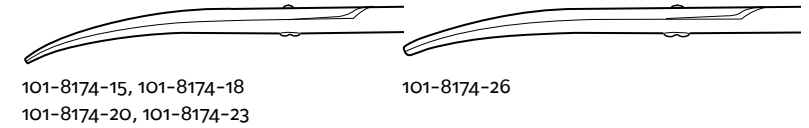

|             |        |              |
|-------------|--------|--------------|
| 101-8174-15 | Curved | 15 cm 6"     |
| 101-8174-18 | Curved | 18 cm 7"     |
| 101-8174-20 | Curved | 20 cm 8"     |
| 101-8174-23 | Curved | 23 cm 9"     |
| 101-8174-26 | Curved | 26 cm 10.25" |



**STILLE-Ekberg Metzenbaum gracil SuperCut ergonomisk dissektionssax | STILLE-Ekberg Metzenbaum Delicate SuperCut Ergonomic Dissecting Scissors**

Ergonomic STILLE-Ekberg version. Available with blades curved up or down, suitable for both left- and right-handed surgeons.



101-8173-153D



101-8173-153U

|               |             |          |
|---------------|-------------|----------|
| 101-8173-153D | Curved down | 15 cm 6" |
| 101-8173-153U | Curved up   | 15 cm 6" |



**STILLE-Ekberg Metzenbaum gracil Diamond SuperCut ergonomisk dissektionssax | STILLE-Ekberg Metzenbaum Delicate Diamond SuperCut Ergonomic Dissecting Scissors**

Diamond version for increased durability.



101-8173-153D-C



101-8173-153U-C

|                 |             |          |
|-----------------|-------------|----------|
| 101-8173-153D-C | Curved down | 15 cm 6" |
| 101-8173-153U-C | Curved up   | 15 cm 6" |



### Metzenbaum STILLE SuperCut XE dissektionssax | Metzenbaum STILLE SuperCut XE Dissecting Scissors

The popular Metzenbaum dissecting scissors with Super Cut edges. Rounded/beveled blades.

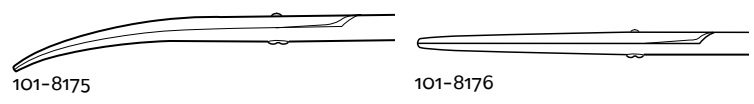

|             |          |              |
|-------------|----------|--------------|
| 101-8175-15 | Curved   | 15 cm 6"     |
| 101-8175-18 | Curved   | 18 cm 7"     |
| 101-8175-20 | Curved   | 20 cm 8"     |
| 101-8175-23 | Curved   | 23 cm 9"     |
| 101-8175-26 | Curved   | 26 cm 10.25" |
| 101-8175-30 | Curved   | 30 cm 12"    |
| 101-8175-33 | Curved   | 33 cm 13"    |
| 101-8176-15 | Straight | 15 cm 6"     |
| 101-8176-18 | Straight | 18 cm 7"     |
| 101-8176-20 | Straight | 20 cm 8"     |
| 101-8176-23 | Straight | 23 cm 9"     |
| 101-8176-26 | Straight | 26 cm 10.25" |



### Metzenbaum STILLE Diamond SuperCut dissektionssax | Metzenbaum STILLE Diamond SuperCut Dissecting Scissors

Diamond version of the popular Metzenbaum STILLE SuperCut scissors, for increased durability.



|               |        |              |
|---------------|--------|--------------|
| 101-8175-15-C | Curved | 15 cm 6"     |
| 101-8175-18-C | Curved | 18 cm 7"     |
| 101-8175-20-C | Curved | 20 cm 8"     |
| 101-8175-23-C | Curved | 23 cm 9"     |
| 101-8175-26-C | Curved | 26 cm 10.25" |
| 101-8175-30-C | Curved | 30 cm 12"    |



**Metzenbaum STILLE SuperCut XE ergonomisk dissektionssax | Metzenbaum STILLE SuperCut XE Ergonomic Dissecting Scissors**

Metzenbaum Super Cut scissors with ergonomically designed shanks for a more comfortable grip. Rounded/beveled blades.



101-8175-152, 101-8175-182

|              |        |          |
|--------------|--------|----------|
| 101-8175-152 | Curved | 15 cm 6" |
| 101-8175-182 | Curved | 18 cm 7" |



**STILLE-Ekberg Metzenbaum SuperCut ergonomisk dissektionssax | STILLE-Ekberg Metzenbaum SuperCut Ergonomic Dissecting Scissors**

Ergonomic STILLE-Ekberg version. Available with blades curved up or down, suitable for both left- and right-handed surgeons.



101-8175-153D



101-8175-153U

|               |             |          |
|---------------|-------------|----------|
| 101-8175-153D | Curved down | 15 cm 6" |
| 101-8175-153U | Curved up   | 15 cm 6" |



## STILLE-Ekberg Metzenbaum Diamond SuperCut ergonomisk dissektionssax | STILLE-Ekberg Diamond Metzenbaum SuperCut Ergonomic Dissecting Scissors

Diamond version for increased durability.

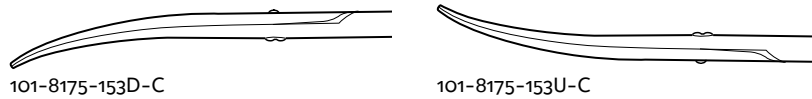

101-8175-153D-C Curved down 15 cm 6"

101-8175-153U-C Curved up 15 cm 6"



### Ragnell STILLE dissektionssax | Ragnell STILLE Dissecting Scissors

Dissecting scissors with flat, rounded tips. Often used in plastic surgery. Is also called Killner by some manufacturers. The short models are used for undermining in plastic surgery and the long models are used for further dissection.

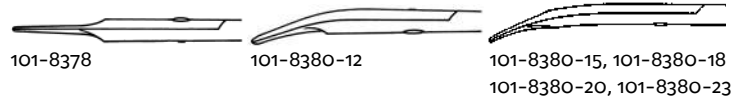

|             |          |            |
|-------------|----------|------------|
| 101-8378    | Straight | 12.5 cm 5" |
| 101-8380-12 | Curved   | 12.5 cm 5" |
| 101-8380-15 | Curved   | 15 cm 6"   |
| 101-8380-18 | Curved   | 18 cm 7"   |
| 101-8380-20 | Curved   | 20 cm 8"   |
| 101-8380-23 | Curved   | 23 cm 9"   |



### Ragnell STILLE SuperCut XE dissektionssax | Ragnell STILLE SuperCut XE Dissecting Scissors

Super Cut version of the Ragnell scissors. For precise undermining of flaps.

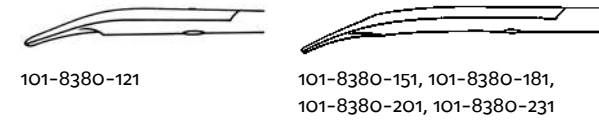

|              |        |            |
|--------------|--------|------------|
| 101-8380-121 | Curved | 12.5 cm 5" |
| 101-8380-151 | Curved | 15 cm 6"   |
| 101-8380-181 | Curved | 18 cm 7"   |
| 101-8380-201 | Curved | 20 cm 8"   |
| 101-8380-231 | Curved | 23 cm 9"   |



### Ragnell STILLE Diamond SuperCut dissektionssax | Ragnell STILLE Diamond SuperCut Dissecting Scissors

Diamond version of the Ragnell STILLE SuperCut scissors, for increased durability.

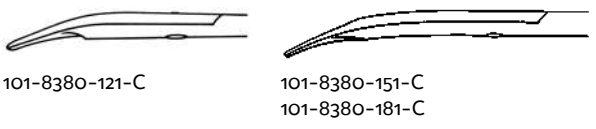

101-8380-121-C      101-8380-151-C  
101-8380-181-C

|                |        |            |
|----------------|--------|------------|
| 101-8380-121-C | Curved | 12.5 cm 5" |
| 101-8380-151-C | Curved | 15 cm 6"   |
| 101-8380-181-C | Curved | 18 cm 7"   |



### STILLE-Ekberg Ragnell SuperCut ergonomisk dissektionssax | STILLE-Ekberg Ragnell SuperCut Ergonomic Dissecting Scissors

Ergonomic STILLE-Ekberg version. Available with blades curved up or down, suitable for both left- and right-handed surgeons.

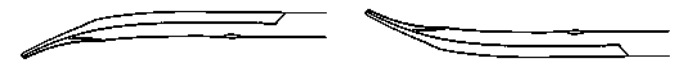

101-8380-153D      101-8380-153U

|               |             |          |
|---------------|-------------|----------|
| 101-8380-153D | Curved down | 15 cm 6" |
| 101-8380-153U | Curved up   | 15 cm 6" |



### STILLE-Ekberg Ragnell Diamond SuperCut ergonomisk dissektionssax | STILLE-Ekberg Ragnell Diamond SuperCut Ergonomic Dissecting Scissors

Diamond version for increased durability.

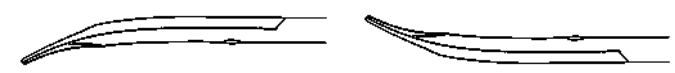

101-8380-153D-C      101-8380-153U-C

|                 |             |          |
|-----------------|-------------|----------|
| 101-8380-153D-C | Curved down | 15 cm 6" |
| 101-8380-153U-C | Curved up   | 15 cm 6" |

**Ragnell STILLE SuperCut XE ergonomisk dissektionssax | Ragnell STILLE SuperCut XE Ergonomic Dissecting Scissors**

Ergo Super Cut versions of Ragnell scissors for precise undermining of flaps and comfortable grip.

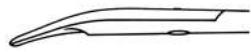

101-8380-122

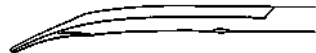

101-8380-152

|              |        |            |
|--------------|--------|------------|
| 101-8380-122 | Curved | 12.5 cm 5" |
|--------------|--------|------------|

|              |        |          |
|--------------|--------|----------|
| 101-8380-152 | Curved | 15 cm 6" |
|--------------|--------|----------|



**Thorek STILLE dissektionssax | Thorek STILLE Dissecting Scissors**

Strongly curved dissecting scissors for good visibility. Rounded blades.

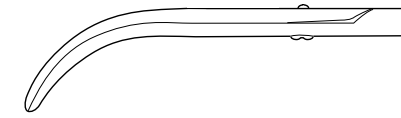

101-8470

|          |                 |             |
|----------|-----------------|-------------|
| 101-8470 | Strongly curved | 21 cm 8.25" |
|----------|-----------------|-------------|





### STILLE Cooper operations sax | STILLE Cooper Operating Scissors

General purpose utility scissors, often used for sutures, gauze etc. Beveled blades.

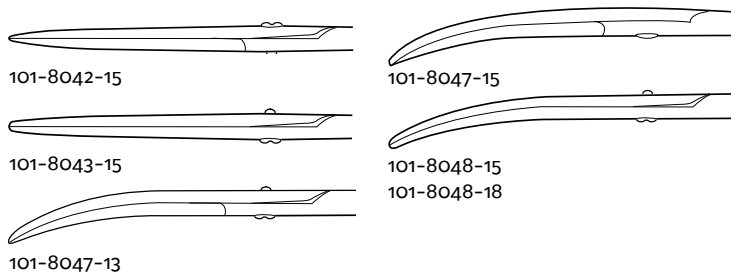

|             |             |          |               |
|-------------|-------------|----------|---------------|
| 101-8042-15 | Sharp/blunt | Straight | 15 cm 6"      |
| 101-8043-15 | Blunt/blunt | Straight | 15 cm 6"      |
| 101-8047-13 | Sharp/blunt | Curved   | 13.5 cm 5.25" |
| 101-8047-15 | Sharp/blunt | Curved   | 15 cm 6"      |
| 101-8048-15 | Blunt/blunt | Curved   | 15 cm 6"      |
| 101-8048-18 | Blunt/blunt | Curved   | 18 cm 7"      |



### Mayo-Harrington STILLE operations sax | Mayo-Harrington STILLE Operating Scissors

Very useful operating scissors for deep surgery like gynecology and thoracic surgery. Beveled blades.

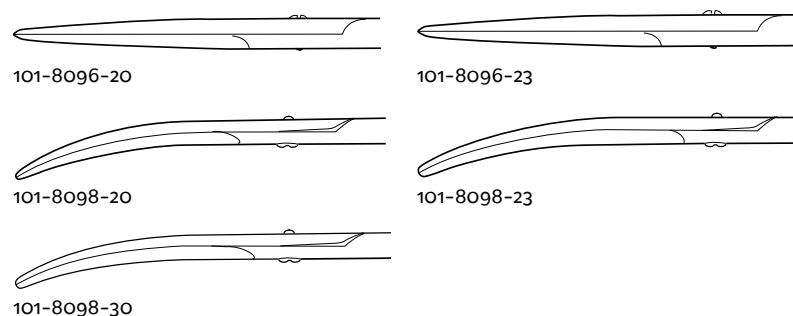

|             |          |           |
|-------------|----------|-----------|
| 101-8096-20 | Straight | 20 cm 8"  |
| 101-8096-23 | Straight | 23 cm 9"  |
| 101-8098-20 | Curved   | 20 cm 8"  |
| 101-8098-23 | Curved   | 23 cm 9"  |
| 101-8098-30 | Curved   | 30 cm 12" |

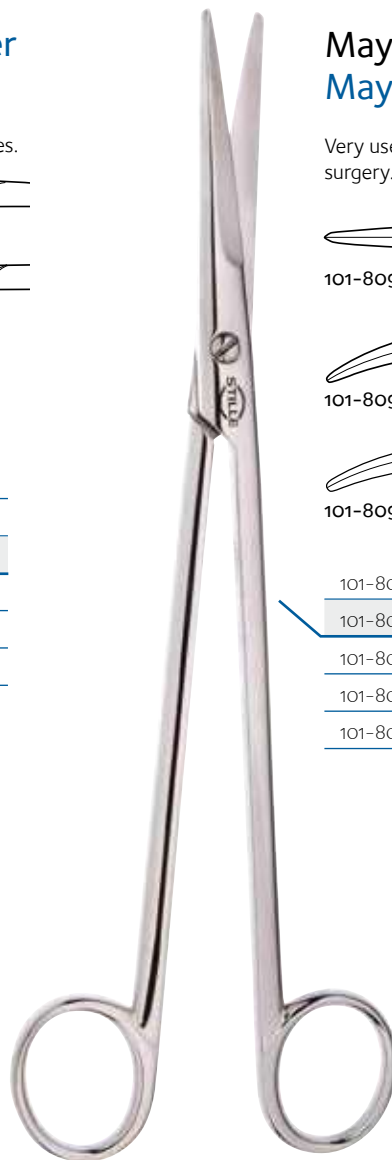

### Mayo-Harrington STILLE SuperCut XE operations sax | Mayo-Harrington STILLE SuperCut XE Operating Scissors

Operating Super Cut scissors useful for several surgical disciplines. Beveled blades.

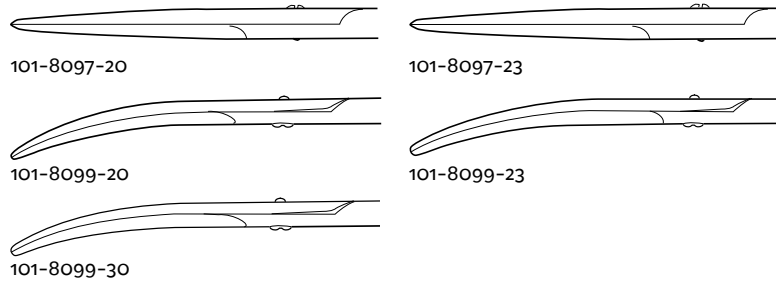

|             |          |           |
|-------------|----------|-----------|
| 101-8097-20 | Straight | 20 cm 8"  |
| 101-8097-23 | Straight | 23 cm 9"  |
| 101-8099-20 | Curved   | 20 cm 8"  |
| 101-8099-23 | Curved   | 23 cm 9"  |
| 101-8099-30 | Curved   | 30 cm 12" |



### Boyd-STILLE tonsillsax | Boyd-STILLE Tonsil Scissors

Scissors with sharp tips and S-shaped shanks for greater visibility. Rounded blades.



101-8420 Curved S-shaped shanks 17 cm 6.75"



### Ragnell STILLE operations sax | Ragnell STILLE Operating Scissors

Mammary plastic scissors intended for breast surgery. Rounded blades.



101-8460

101-8460 Angled 17 cm 6.75"



### König-STILLE nageluppklippnings sax | König-STILLE Nail-splitting Scissors

Nail-splitting scissors, for cutting up ingrown nails. Beveled blades.

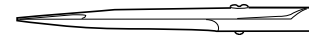

101-8580

101-8580 Straight 15 cm 6"



### Stevens-STILLE tenotomisax | Stevens-STILLE Tenotomy Scissors

Tenotomy scissors with rounded, very thin blades and tapered tips. Used in plastic surgery and hand surgery for cutting with extreme precision in small incisions.



|          |          |            |
|----------|----------|------------|
| 101-8166 | Straight | 12.5 cm 5" |
| 101-8167 | Curved   | 12.5 cm 5" |



### Stevens-STILLE SuperCut tenotomisax | Stevens-STILLE SuperCut Tenotomy Scissors

Very popular SuperCut XE scissors for precise cutting and dissection of fine tissues. Rounded blades.

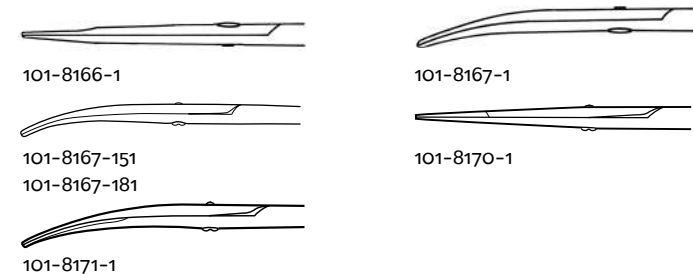

|              |          |              |
|--------------|----------|--------------|
| 101-8166-1   | Straight | 12.5 cm 5"   |
| 101-8167-1   | Curved   | 12.5 cm 5"   |
| 101-8167-151 | Curved   | 15 cm 6"     |
| 101-8167-181 | Curved   | 18 cm 7"     |
| 101-8170-1   | Straight | 9.5 cm 3.75" |
| 101-8171-1   | Curved   | 9.5 cm 3.75" |



## Stevens-STILLE Diamond SuperCut tenotomisax | Stevens-STILLE Diamond SuperCut Tenotomy Scissors

Diamond version for increased durability.



101-8167-1-C

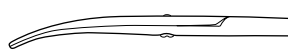

101-8167-151-C

101-8167-181-C

|                |        |            |
|----------------|--------|------------|
| 101-8167-1-C   | Curved | 12.5 cm 5" |
| 101-8167-151-C | Curved | 15 cm 6"   |
| 101-8167-181-C | Curved | 18 cm 7"   |



### Stevens-STILLE SuperCut XE ergonomisk tenotomisax | Stevens-STILLE SuperCut XE Ergonomic Tenotomy Scissors

Ergonomic design of the popular Stevens SuperCut XE tenotomy scissors.

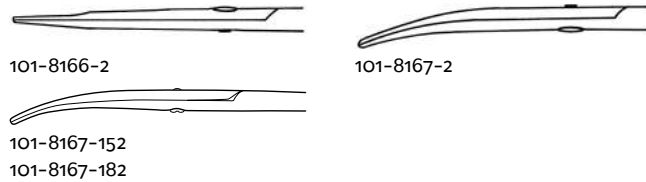

|              |          |            |
|--------------|----------|------------|
| 101-8166-2   | Straight | 12.5 cm 5" |
| 101-8167-2   | Curved   | 12.5 cm 5" |
| 101-8167-152 | Curved   | 15 cm 6"   |
| 101-8167-182 | Curved   | 18 cm 7"   |



### Stevens-STILLE Diamond SuperCut ergonomisk tenotomisax | Stevens-STILLE Diamond Ergonomic SuperCut Tenotomy Scissors

Diamond version for increased durability.

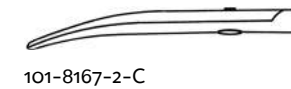

101-8167-2-C Curved 12.5 cm 5"



STILLE-Ekberg Stevens SuperCut ergonomisk tenotomisax | **STILLE-Ekberg Stevens Ergonomic SuperCut Tenotomy Scissors**

Ergonomic STILLE-Ekberg version. Available with blades curved up or down, suitable for both left- and right-handed surgeons.



101-8167-153D



101-8167-153U

|               |             |          |
|---------------|-------------|----------|
| 101-8167-153D | Curved down | 15 cm 6" |
|---------------|-------------|----------|

|               |           |          |
|---------------|-----------|----------|
| 101-8167-153U | Curved up | 15 cm 6" |
|---------------|-----------|----------|



STILLE-Ekberg Stevens Diamond SuperCut ergonomisk tenotomisax | **STILLE-Ekberg Stevens Diamond Ergonomic SuperCut Tenotomy Scissors**

Diamond version for increased durability.



101-8167-153D-C



101-8167-153U-C

|                 |             |          |
|-----------------|-------------|----------|
| 101-8167-153D-C | Curved down | 15 cm 6" |
|-----------------|-------------|----------|

|                 |           |          |
|-----------------|-----------|----------|
| 101-8167-153U-C | Curved up | 15 cm 6" |
|-----------------|-----------|----------|



### STILLE SuperCut XE kärlsax | STILLE SuperCut XE Vascular Scissors

Super Cut scissors with angled blades for better reach of vessels etc.  
Used in vascular surgery.

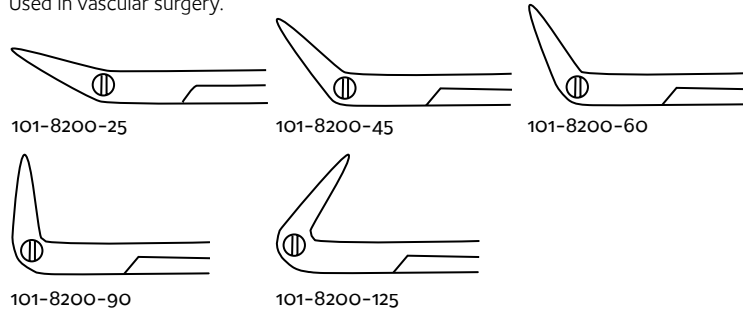

|              |             |             |
|--------------|-------------|-------------|
| 101-8200-25  | Angled 25°  | 18 cm 7"    |
| 101-8200-45  | Angled 45°  | 18 cm 7"    |
| 101-8200-60  | Angled 60°  | 18 cm 7"    |
| 101-8200-90  | Angled 90°  | 17 cm 6.75" |
| 101-8200-125 | Angled 125° | 17 cm 6.75" |

### STILLE SuperCut XE kärlsax | STILLE SuperCut XE Vascular Scissors

Extra delicate version of the popular STILLE Vascular Scissor with shorter and thinner blades.

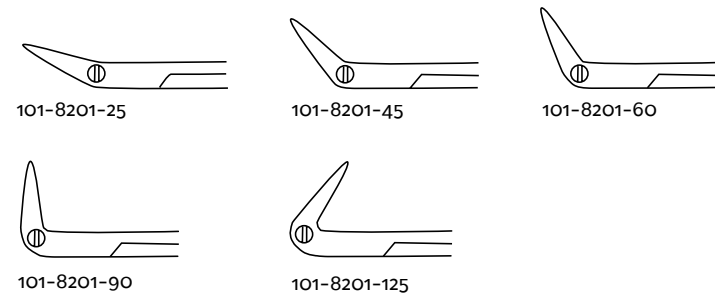

|              |             |             |
|--------------|-------------|-------------|
| 101-8201-25  | Angled 25°  | 18 cm 7"    |
| 101-8201-45  | Angled 45°  | 18 cm 7"    |
| 101-8201-60  | Angled 60°  | 18 cm 7"    |
| 101-8201-90  | Angled 90°  | 17 cm 6.75" |
| 101-8201-125 | Angled 125° | 17 cm 6.75" |

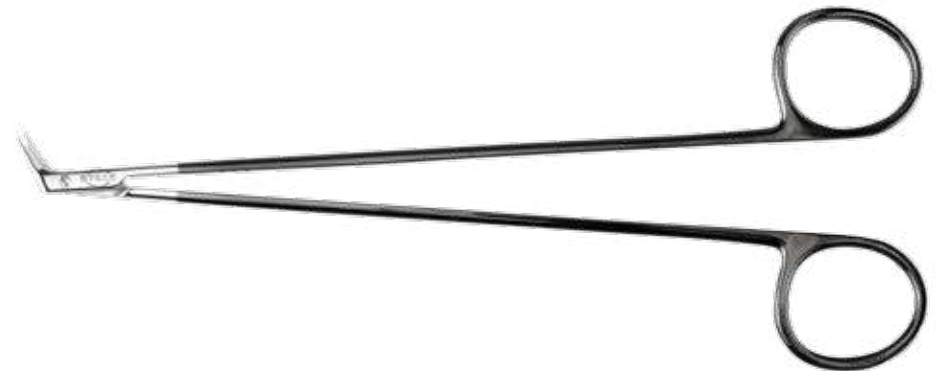
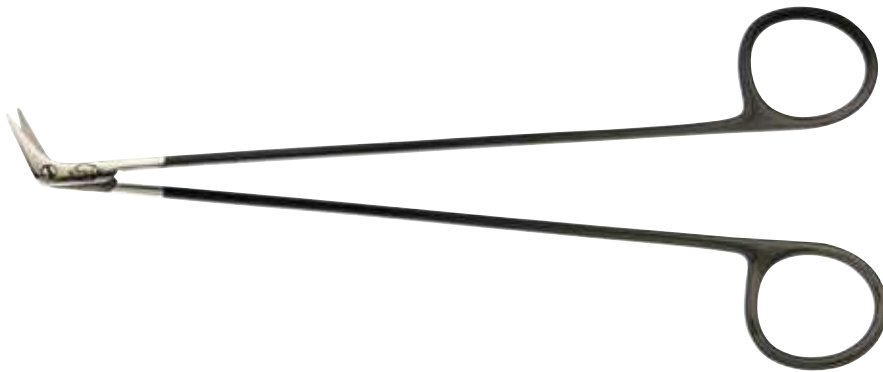



## STILLE-Lund kärlsax | STILLE-Lund Vascular Scissors

Vascular scissors with one sharp and one probe-pointed blade for precise handling of fine blood vessels. Popular model in pathology procedures.

|            |                       |      |          |          |
|------------|-----------------------|------|----------|----------|
| 101-8490   | 1 probe-pointed blade |      | Straight | 15 cm 6" |
| 101-8490-2 | 1 probe-pointed blade | Ergo | Straight | 15 cm 6" |



**Fomon STILLE nässax | Fomon STILLE Nasal Scissors**

Scissors for rhinoplasty. Double-beveled blades.

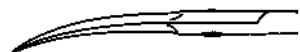

101-8025

|          |        |            |
|----------|--------|------------|
| 101-8025 | Curved | 12.5 cm 5" |
|----------|--------|------------|

**Joseph STILLE nässax | Joseph STILLE Nasal Scissors**

Nasal scissors for the lower lateral cartilage. Useful in dissecting and cutting tough tissue. Beveled blades.

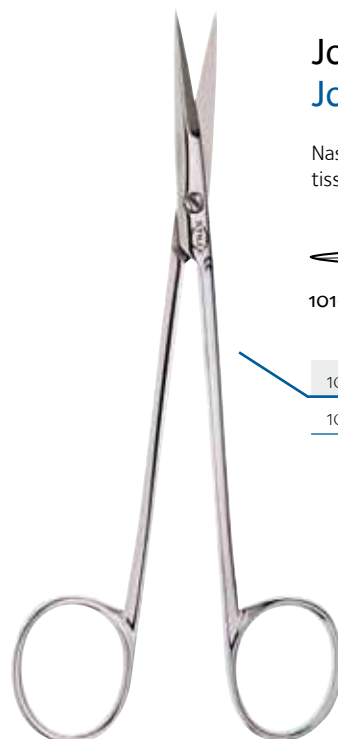

101-8110



101-8115

|          |          |          |
|----------|----------|----------|
| 101-8110 | Straight | 15 cm 6" |
| 101-8115 | Curved   | 15 cm 6" |

**Joseph STILLE SuperCut XE nässax | Joseph STILLE SuperCut XE Nasal Scissors**

Super Cut nasal scissors for the lower lateral cartilage. Useful in dissecting and cutting tough tissue. Beveled blades.



101-8110



101-8115

|            |          |          |
|------------|----------|----------|
| 101-8110-1 | Straight | 15 cm 6" |
| 101-8115-1 | Curved   | 15 cm 6" |

### Peck-Joseph STILLE nässax | Peck-Joseph STILLE Nasal Scissors

Double-beveled scissors for rhinoplasty.

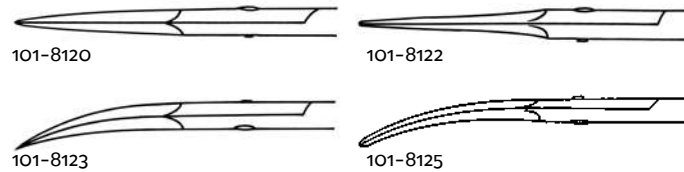

|          |       |          |          |
|----------|-------|----------|----------|
| 101-8120 | Sharp | Straight | 15 cm 6" |
| 101-8122 | Blunt | Straight | 15 cm 6" |
| 101-8123 | Sharp | Curved   | 15 cm 6" |
| 101-8125 | Blunt | Curved   | 15 cm 6" |

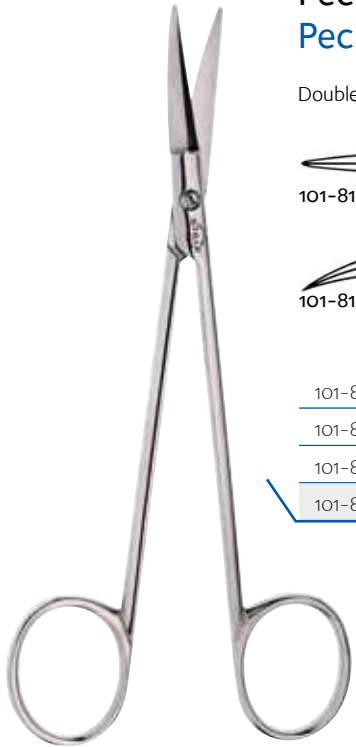

### Peck-Joseph STILLE SuperCut XE nässax | Peck-Joseph STILLE SuperCut XE Nasal Scissors

Double-beveled scissors for rhinoplasty.

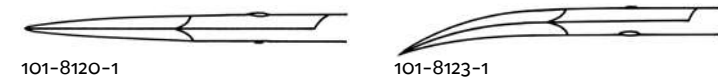

|            |       |          |          |
|------------|-------|----------|----------|
| 101-8120-1 | Sharp | Straight | 15 cm 6" |
| 101-8123-1 | Sharp | Curved   | 15 cm 6" |



**STILLE SuperCut XE nässax |**  
**STILLE SuperCut XE Nasal Scissors**

SuperCut XE nasal scissors for excision of cartilage.



101-8411

101-8411 Straight Angled shanks 18 cm 7"



**STILLE Fomon SuperCut XE nässax |**  
**STILLE Fomon SuperCut XE Nasal Scissors**

Serrated SuperCut XE scissors for cutting dorsal cartilage. Angled shanks for better visibility.



101-8425

101-8425 Serrated blades Angled shanks 14 cm 5.5"



## STILLE Cottle SuperCut XE nässax | STILLE Cottle SuperCut XE Nasal Scissors

SuperCut XE scissors with heavy blades for cutting dorsal cartilage. Angled shanks for better visibility. Serrated blades.

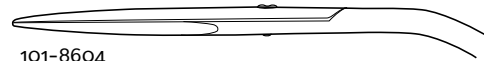

101-8604

101-8604 Serrated blades Angled shanks 16 cm 6.25"



### Gorney STILLE SuperCut XE Face-lift sax | Gorney STILLE SuperCut XE Face-lift scissors

Super Cut double-beveled face-lift scissors with flat tips and semi-sharp outer blades. Two models with serrated blades to prevent tissue slippage.

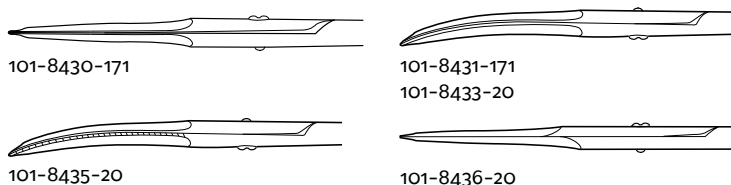
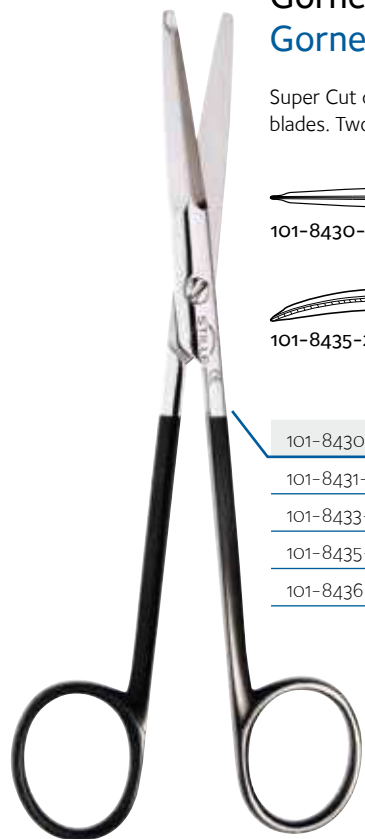

101-8430-171

101-8431-171  
101-8433-20

101-8435-20

101-8436-20

|              |          |          |             |
|--------------|----------|----------|-------------|
| 101-8430-171 | Straight |          | 17 cm 6.75" |
| 101-8431-171 | Curved   |          | 17 cm 6.75" |
| 101-8433-20  | Curved   |          | 20 cm 8"    |
| 101-8435-20  | Curved   | Serrated | 20 cm 8"    |
| 101-8436-20  | Straight | Serrated | 20 cm 8"    |

### Gorney STILLE SuperCut XE ergonomisk Face-lift sax | Gorney STILLE SuperCut XE Ergonomic Face-lift scissors

Ergonomic design to avoid fatigue in the hand. One model with serrated blades to prevent tissue slippage. Flat tips and semi-sharp outer blades.

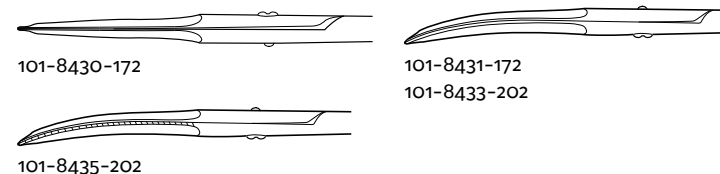
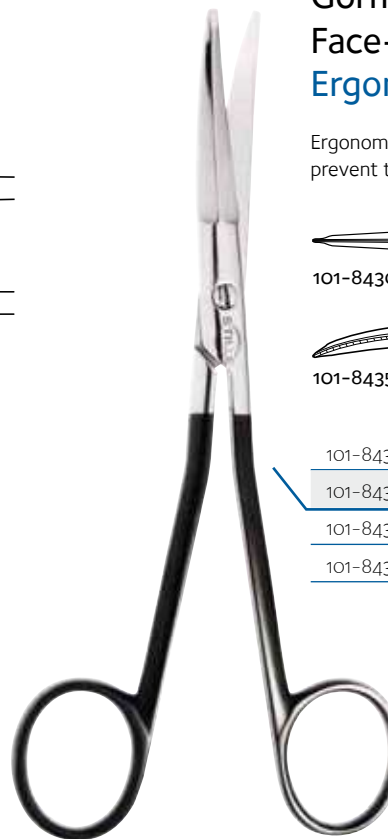

101-8430-172

101-8431-172  
101-8433-202

101-8435-202

|              |          |          |             |
|--------------|----------|----------|-------------|
| 101-8430-172 | Straight |          | 17 cm 6.75" |
| 101-8431-172 | Curved   |          | 17 cm 6.75" |
| 101-8433-202 | Curved   |          | 20 cm 8"    |
| 101-8435-202 | Curved   | Serrated | 20 cm 8"    |

### Aston STILLE SuperCut XE Face-lift sax | Aston STILLE SuperCut XE Face-lift scissors

Double-beveled SuperCut XE face-lift scissors with semi-sharp outer blades for undermining flaps.



101-8440-201



101-8441-201



101-8442-171

|              |          |          |               |
|--------------|----------|----------|---------------|
| 101-8440-201 | Straight |          | 20 cm 8 in    |
| 101-8441-201 | Curved   |          | 20 cm 8 in    |
| 101-8442-171 | Curved   | Serrated | 17 cm 6.75 in |



### Davis STILLE SuperCut XE Face-lift sax | Davis STILLE SuperCut XE Face-lift Scissors

SuperCut XE face-lift scissors with tapered blades and sharp tips for precise cutting and dissection.



101-8452

|          |        |          |
|----------|--------|----------|
| 101-8452 | Curved | 18 cm 7" |
|----------|--------|----------|

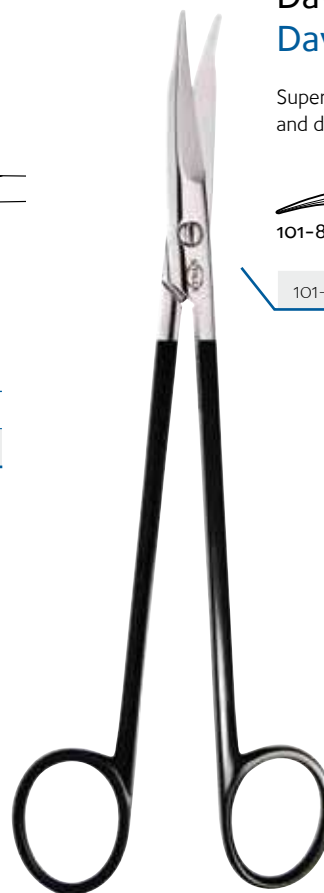

**Rees STILLE SuperCut XE Face-lift sax |  
Rees STILLE SuperCut XE Face-lift scissors**

SuperCut XE face-lift scissors, double-beveled with semi-sharp outer blades for undermining skin flaps.



101-8456-171

|              |        |             |
|--------------|--------|-------------|
| 101-8456-171 | Curved | 17 cm 6.75" |
|--------------|--------|-------------|



**Matarasso STILLE SuperCut XE Face-lift sax |  
Matarasso STILLE SuperCut XE Face-lift scissors**

SuperCut XE face-lift scissors with double-beveled semi-sharp outer blades.



101-8458



101-8459-20

|             |          |             |
|-------------|----------|-------------|
| 101-8458-17 | Curved   | 17 cm 6.75" |
| 101-8458-20 | Curved   | 20 cm 8"    |
| 101-8459-20 | Straight | 20 cm 8"    |



**Matarasso STILLE SuperCut XE ergonomisk  
Face-lift sax | Matarasso STILLE SuperCut XE  
Ergonomic Face-lift scissors**

Ergonomic version of the Matarasso SuperCut XE face-lift scissors with double-beveled semi-sharp outer blades.



101-8458

|              |        |             |
|--------------|--------|-------------|
| 101-8458-172 | Curved | 17 cm 6.75" |
| 101-8458-202 | Curved | 20 cm 8"    |





### Littler STILLE trådföringssax | Littler STILLE Suture carrying scissors

Suture carrying scissors. Rounded blades.



101-8164

101-8164 Curved 12.5 cm 5"



**STILLE sutursax | STILLE Suture scissors**

Suture removal scissors.



101-8584

101-8584 Curved 13.5 cm 5.25"

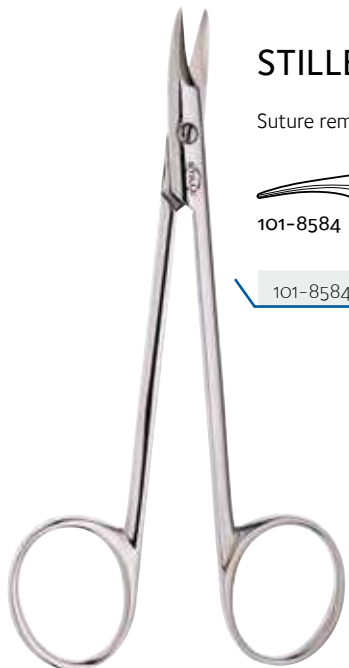

**Spencer STILLE sutursax | Spencer STILLE Suture scissors**

Popular suture scissors for many procedures. Delicate model.

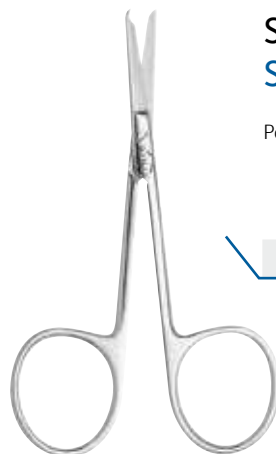

101-8586-9 9 cm 3.5"

**Lister STILLE TC bandagesax | Lister STILLE TC Bandage Scissors**

Bandage scissors with TC-inserts for improved durability.



101-8595-18 TC-inserts 18 cm 7"



**Littauer STILLE sutursax |  
Littauer STILLE Suture scissors**

A somewhat larger model than Spencer. Used in many procedures.

101-8597-14 Delicate pattern 14 cm 5.5"

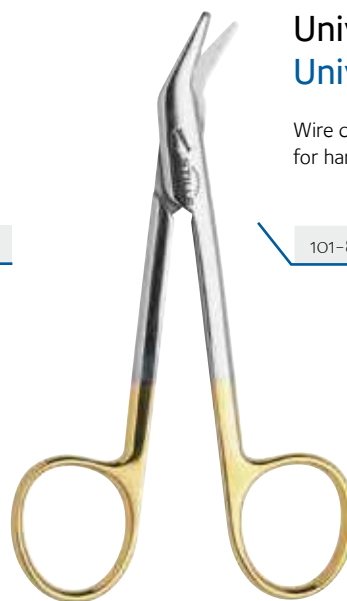

**Universal STILLE ståltrådssax |  
Universal STILLE Wire Cutting scissors**

Wire cutting scissors with TC-inserts. For soft wire up to 1.2 mm,  
for hard wire up to 0.8 mm.

101-8815-12 TC 12 cm 4.75"



**SOM EN FÖRLÄNGNING** av kirurgens tumme och pekfinger måste pincetten kunna fatta och släppa taget med samma känslighet som hos ett par fingertoppar. Klorna på de kirurgiska pincetterna är därför speciellt formgivna för att fatta ett fast, men ändå mildt, grepp om vävnaden. De anatomiska pincetterna är tillverkade för att kunna ta ett så atraumatiskt grepp som möjligt om känslig vävnad.

Det är finjusteringen som skapar den perfekta balansen med ett följsamt, fjädrande motstånd och ett stadigt grepp. Den karrerade ytan ökar greppbarheten ytterligare. Det ger kirurgen full kontroll samtidigt som det orsakar så lite skada på vävnaden som möjligt.

Pincetten hör till de kirurgiska instrument som grundaren Albert Stille lärde sig att tillverka från grunden redan under sina lärlingsår på 1830-talet. Ett till synes enkelt hjälpmedel som dock kräver exakt precision vid tillverkningen. Genom åren har STILLES pincetter fortsatt att förfinas och de är idag erkända för sin unikt mjuka känsla och goda balans i kombination med sin oöverträffade livslängd.

**AS AN EXTENSION OF THE SURGEON'S THUMB** and forefinger, forceps need to grasp and release with the same sensitivity as a pair of fingertips. The claws on surgical forceps are specially designed to make a firm, yet gentle, grasp of the tissue. The anatomical forceps are designed, as much as possible, to take an atraumatic grip on sensitive tissue.

It is the fine tuning that creates the perfect balance with a smooth, resilient spring action and a firm grip. The surface grooves increase gripping power even further. This gives the surgeon full control while causing as little harm to the tissue as possible.

Forceps are among the surgical instruments that founder Albert Stille learned to make from scratch during his apprenticeship in the 1830's. Forceps are seemingly simple instrument but still demands ultra-precision in the manufacturing process. Over the years, STILLE's forceps continue to be refined and are today recognized for their unique feel and excellent balance in combination with unsurpassed longevity.



# Pincetter | Forceps | Pinzetten | Pinze | Pinzas |

## 鑷子 (ピンセット)

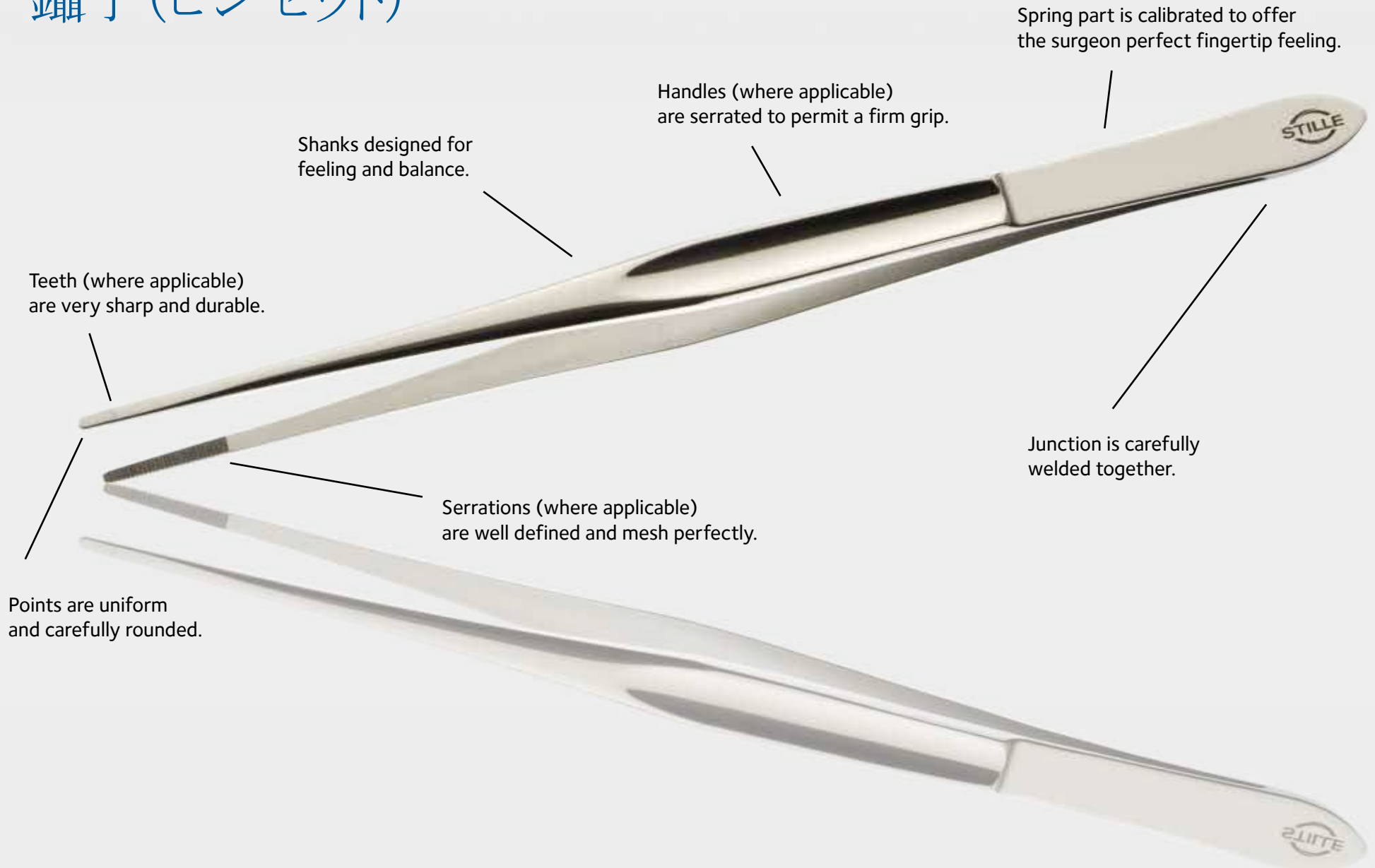



### Adson STILLE pincett | Adson STILLE Tissue Forceps

Tissue forceps with very delicate points and 1x2 fine teeth. Used in most specialties for delicate work.



102-9019



102-9022  
102-9022-15

|          |               |           |             |
|----------|---------------|-----------|-------------|
| 102-9019 | Very delicate | 1x2 teeth | 12 cm 4.75" |
|----------|---------------|-----------|-------------|

|          |                |           |             |
|----------|----------------|-----------|-------------|
| 102-9022 | Cross-serrated | 1x2 teeth | 12 cm 4.75" |
|----------|----------------|-----------|-------------|

|             |                |           |          |
|-------------|----------------|-----------|----------|
| 102-9022-15 | Cross-serrated | 1x2 teeth | 15 cm 6" |
|-------------|----------------|-----------|----------|



### Adson-Brown STILLE pincett | Adson-Brown STILLE Tissue Forceps

Tissue forceps with side-grasping teeth for secure, atraumatic grasping of soft tissue or cartilage.



102-9023-12

|             |                     |             |
|-------------|---------------------|-------------|
| 102-9023-12 | Side-grasping teeth | 12 cm 4.75" |
|-------------|---------------------|-------------|



### Adson-Callison STILLE pincett | Adson-Callison STILLE Tissue Forceps

Tissue forceps with tying platform and 1x2 fine teeth.



102-9021

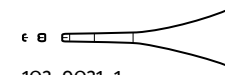

102-9021-1

|          |                |           |             |
|----------|----------------|-----------|-------------|
| 102-9021 | Tying platform | 1x2 teeth | 12 cm 4.75" |
|----------|----------------|-----------|-------------|

|            |                         |           |             |
|------------|-------------------------|-----------|-------------|
| 102-9021-1 | Delicate tying platform | 1x2 teeth | 12 cm 4.75" |
|------------|-------------------------|-----------|-------------|

### Gillies STILLE pincett | Gillies STILLE Tissue Forceps

Tissue forceps with 1x2 fine teeth and stabilizing pin. An excellent forceps for the surgeon who wants an Adson-size tip, but with greater length.



102-9027

|          |          |                |               |
|----------|----------|----------------|---------------|
| 102-9027 | Serrated | 1x2 fine teeth | 15,5 cm 6.25" |
|----------|----------|----------------|---------------|



### STILLE pincett | STILLE Tissue Forceps

Tissue forceps with 1x2 fine teeth and stabilizing pin. Delicate model.



102-9028

|          |          |                |               |
|----------|----------|----------------|---------------|
| 102-9028 | Serrated | 1x2 fine teeth | 15,5 cm 6.25" |
|----------|----------|----------------|---------------|



### STILLE pincett | STILLE Tissue Forceps

Tissue forceps with 1x2 teeth.



102-9060

|             |           |             |
|-------------|-----------|-------------|
| 102-9060-15 | 1x2 teeth | 15 cm 6"    |
| 102-9060-17 | 1x2 teeth | 17 cm 6.75" |
| 102-9060-20 | 1x2 teeth | 20 cm 8"    |



### STILLE pincett | STILLE Tissue Forceps

Tissue forceps with 1x2 fine teeth.



102-9050-13

|             |                |          |
|-------------|----------------|----------|
| 102-9050-13 | 1x2 fine teeth | 13 cm 5" |
|-------------|----------------|----------|



### STILLE pincett | STILLE Tissue Forceps

Tissue forceps with 2x3 teeth. Used when more grasping power than 1x2 teeth is needed.



102-9062

|             |           |             |
|-------------|-----------|-------------|
| 102-9062-15 | 2x3 teeth | 15 cm 6"    |
| 102-9062-17 | 2x3 teeth | 17 cm 6.75" |
| 102-9062-20 | 2x3 teeth | 20 cm 8"    |





### Adlercreutz STILLE pincett | Adlercreutz STILLE Tissue Forceps

Tissue forceps with 4x5 fine teeth. Very useful in neurosurgery to hold the dura, and in cardiovascular surgery to hold the pericardium.



|             |                |           |
|-------------|----------------|-----------|
| 102-9248-15 | 4x5 fine teeth | 15 cm 6"  |
| 102-9248-20 | 4x5 fine teeth | 20 cm 8"  |
| 102-9248-25 | 4x5 fine teeth | 25 cm 10" |

### Waugh-Brophy STILLE pincett | Waugh-Brophy STILLE Tissue Forceps

Tissue forceps with 1x2 fine teeth. Very fine tips, like Adson. Useful when long and slender instruments are needed.



102-9252

|             |           |                |           |
|-------------|-----------|----------------|-----------|
| 102-9252-20 | 1x2 teeth | Cross-serrated | 20 cm 8"  |
| 102-9252-25 | 1x2 teeth | Cross-serrated | 25 cm 10" |
| 102-9252-30 | 1x2 teeth | Cross-serrated | 30 cm 12" |



### Russian STILLE pincett | Russian STILLE Tissue Forceps

Forceps for secure grip of tissue. Used when a better grip than with a dressing forceps is needed, and when damage to the tissue must be avoided. For hard and slippery tissue.

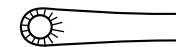

102-9270-20

|             |          |
|-------------|----------|
| 102-9270-20 | 20 cm 8" |
|-------------|----------|







### Adson STILLE anatomisk pincett | Adson STILLE Dressing Forceps

General-purpose dressing forceps with various types of jaw surfaces.

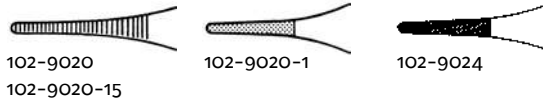

|             |                        |             |
|-------------|------------------------|-------------|
| 102-9020    | Serrated               | 12 cm 4.75" |
| 102-9020-15 | Serrated               | 15 cm 6"    |
| 102-9020-1  | Diamond jaws           | 12 cm 4.75" |
| 102-9024    | TC jaws cross-serrated | 12 cm 4.75" |



### McIndoe STILLE anatomisk pincett | McIndoe STILLE Dressing Forceps

Dressing forceps with stabilizing pin and delicate jaws for grasping fine tissue.

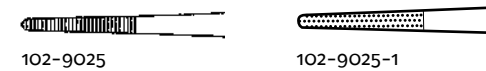

|            |              |               |
|------------|--------------|---------------|
| 102-9025   | Serrated     | 15,5 cm 6.25" |
| 102-9025-1 | Diamond Jaws | 15,5 cm 6.25" |

### STILLE anatomisk pincett | STILLE Dressing Forceps

Dressing forceps with square shaped and serrated points used in all surgical specialties.

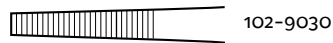

|             |               |             |
|-------------|---------------|-------------|
| 102-9030-13 | Square points | 13 cm 5"    |
| 102-9030-15 | Square points | 15 cm 6"    |
| 102-9030-17 | Square points | 17 cm 6.75" |
| 102-9030-20 | Square points | 20 cm 8"    |
| 102-9030-25 | Square points | 25 cm 10"   |



### STILLE anatomisk pincett | STILLE Dressing Forceps

Dressing forceps with rounded points and serrated jaws.



|             |                |             |
|-------------|----------------|-------------|
| 102-9040-15 | Rounded points | 15 cm 6"    |
| 102-9040-17 | Rounded points | 17 cm 6.75" |
| 102-9040-20 | Rounded points | 20 cm 8"    |
| 102-9040-25 | Rounded points | 25 cm 10"   |
| 102-9040-30 | Rounded points | 30 cm 12"   |





**Crafoord-STILLE anatomisk pincett |  
Crafoord-STILLE Dressing Forceps**

Dressing forceps with rounded points. The perfect balance and delicate grip gives this instrument a unique feeling.

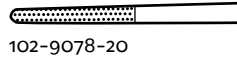
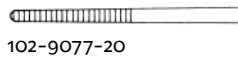

|             |              |          |
|-------------|--------------|----------|
| 102-9077-20 | Serrated     | 20 cm 8" |
| 102-9078-20 | Diamond jaws | 20 cm 8" |



**Waugh-Brophy STILLE anatomisk pincett |  
Waugh-Brophy STILLE Dressing Forceps**

Dressing forceps with very fine points and two different jaw surfaces. The cross-serration gives excellent holding power.

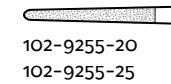
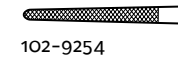

|             |                 |           |
|-------------|-----------------|-----------|
| 102-9254    | Cross- serrated | 20 cm 8"  |
| 102-9255-20 | Diamond jaws    | 20 cm 8"  |
| 102-9255-25 | Diamond jaws    | 25 cm 10" |

## Olivecrona-STILLE durapincett | Olivecrona-STILLE Dura Forceps

Dura forceps with 2x3 fine teeth. The nonpenetrating tips give the surgeon maximum grip without damaging the tissue.



102-9244-15 2x3 fine teeth 15 cm 6"

102-9244-20 2x3 fine teeth 20 cm 8"

102-9244-25 2x3 fine teeth 25 cm 10"



## STILLE irispincett | STILLE Iris Forceps

Short delicate forceps with either 1x2 fine teeth or serrated jaws.

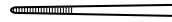

102-9460

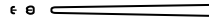

102-9470

|          |           |          |
|----------|-----------|----------|
| 102-9460 | Serrated  | 10 cm 4" |
| 102-9470 | 1x2 teeth | 10 cm 4" |





### STILLE De Bakey kärlpincett | STILLE De Bakey Vascular Forceps

Atraumatic forceps with De Bakey jaws for handling of blood vessels and other delicate tissue. Can be insulated on request.



102-9300 102-9302 102-9312 102-9314 102-9320  
102-9304 102-9316 102-9318 102-9322

|          |               |        |              |
|----------|---------------|--------|--------------|
| 102-9340 | De Bakey type | 1 mm   | 15 cm 6"     |
| 102-9342 | De Bakey type | 1 mm   | 20 cm 8"     |
| 102-9354 | De Bakey type | 1.5 mm | 25 cm 10"    |
| 102-9300 | De Bakey type | 2 mm   | 15 cm 6"     |
| 102-9302 | De Bakey type | 2 mm   | 20 cm 8"     |
| 102-9304 | De Bakey type | 2 mm   | 25 cm 10"    |
| 102-9312 | De Bakey type | 2.7 mm | 15 cm 6"     |
| 102-9314 | De Bakey type | 2.7 mm | 20 cm 8"     |
| 102-9316 | De Bakey type | 2.7 mm | 25 cm 10"    |
| 102-9318 | De Bakey type | 2.7 mm | 30 cm 11.75" |
| 102-9320 | De Bakey type | 3.2 mm | 20 cm 8"     |
| 102-9322 | De Bakey type | 3.2 mm | 25 cm 10"    |



### STILLE De Bakey kärlpincett | STILLE De Bakey Vascular Forceps

Angled atraumatic forceps with De Bakey jaws for delicate tissue.

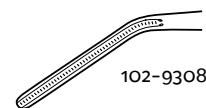

102-9308 De Bakey type 2 mm 20 cm 8"



### STILLE De Bakey kärlpincett | STILLE De Bakey Vascular Forceps

Atraumatic forceps with De Bakey jaws for delicate tissue, non serrated handles. Stop pin for preventing from gripping the tissue too hard.



102-9330

102-9330 De Bakey type 2 mm 20 cm 8"



**Waugh-Brophy STILLE isolerad diatermipincett |  
 Waugh-Brophy STILLE insulated Diathermy  
 Forceps**

Insulated version of the popular Waugh-Brophy forceps. Used in monopolar diathermy with 1x2 teeth.



102-9852

102-9852-20 1x2 teeth Cross-serrated 20 cm 8"

102-9852-25 1x2 teeth Cross-serrated 25 cm 10"

102-9852-30 1x2 teeth Cross-serrated 30 cm 12"

**Björk-STILLE diatermipincetter | Björk-STILLE  
 Diathermy Forceps**

Insulated forceps for monopolar diathermy. Serrations allow grasping of delicate structures.



102-9845

102-9845-15 Insulated 15 cm 6"

102-9845-20 Insulated 20 cm 8"

102-9845-25 Insulated 25cm 10"

**Waugh-Brophy STILLE isolerad diatermipincett |  
 Waugh-Brophy STILLE insulated Diathermy  
 Forceps**

Insulated version of the popular Waugh-Brophy forceps. Used in monopolar diathermy. With Diamond Jaws.



102-9855

102-9855-20 Diamond jaws 20 cm 8"

102-9855-25 Diamond jaws 25 cm 10"



## Björk–STILLE knutpincett | Björk–STILLE Knot-Holding Forceps

Same as Björk–STILLE diathermy forceps, but without insulation.



102-9846-20

102-9846-20

20 cm 8 in





**STILLES PEANGER** har en unik och gracil design med mjuka former, alltid med kirurgens specifika behov i fokus. Det öppna boxlåset förenklar rengöringen och minimerar risken för att kirurgens handskar eller suturer ska fastna i instrumentet. Utformningen av det speciella knäppet är unik och håller alltid peangen stängd i en säker position. Samtidigt är knäppet mycket lätt och smidigt att öppna så att kirurgen hela tiden har full kontroll.

Käftarna har rundade kanter och perfekt passform mot varandra. Det finns ingen risk för att de ska släppa greppet. Peangen stängs och öppnas lika snabbt och smidigt med ett enkelt handgrepp. Därför upplevs den som mycket mjukare och med en spänst som inga andra fabrikat kan erbjuda.

Konstruktionen har fortsatt att förbättras under årens lopp och många försök har gjorts att kopiera STILLES egenutvecklade design. Den oöverträffade livslängden gör peangerna till en god investering som kan användas under många år.

**STILLE'S ARTERY FORCEPS** have a unique and graceful design featuring soft shapes, always with the surgeon's specific needs in mind. The open box lock simplifies cleaning and minimizes the risk of the surgeon's gloves or sutures becoming entangled in the instrument. The design of the special ratchet is unique and always keeps the forceps closed in a secure position. At the same time the ratchet is very easy and convenient to open, giving the user full control.

The jaws have rounded edges and fit perfectly together. There is no risk of losing grip. The instrument closes and opens quickly and smoothly with a simple operation. STILLE artery forceps have a softer feel with performance properties that no other brand can offer.

The manufacturing technique has continued to improve over the years and many attempts have been made to imitate STILLE's proprietary design. The unsurpassed longevity makes these instruments a good investment that will be in service for many years.

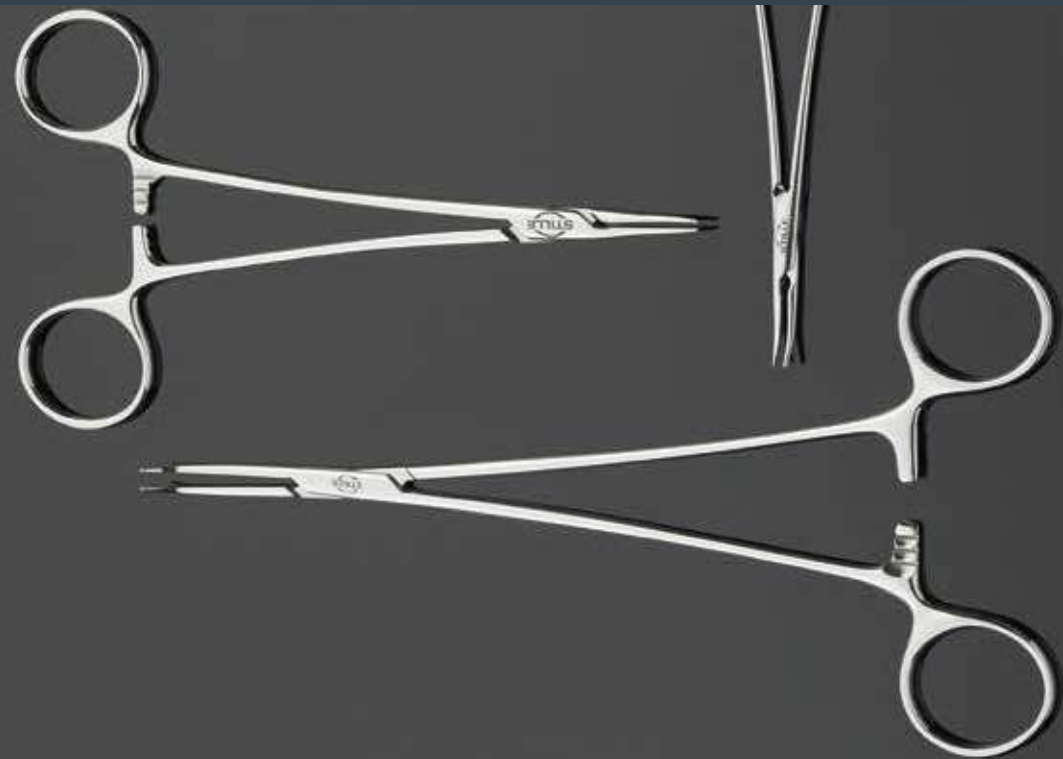



Peanger | Artery forceps | Arterienklemmen |  
Pinze emostatiche | Pinzas hemostáticas | 止血鉗子

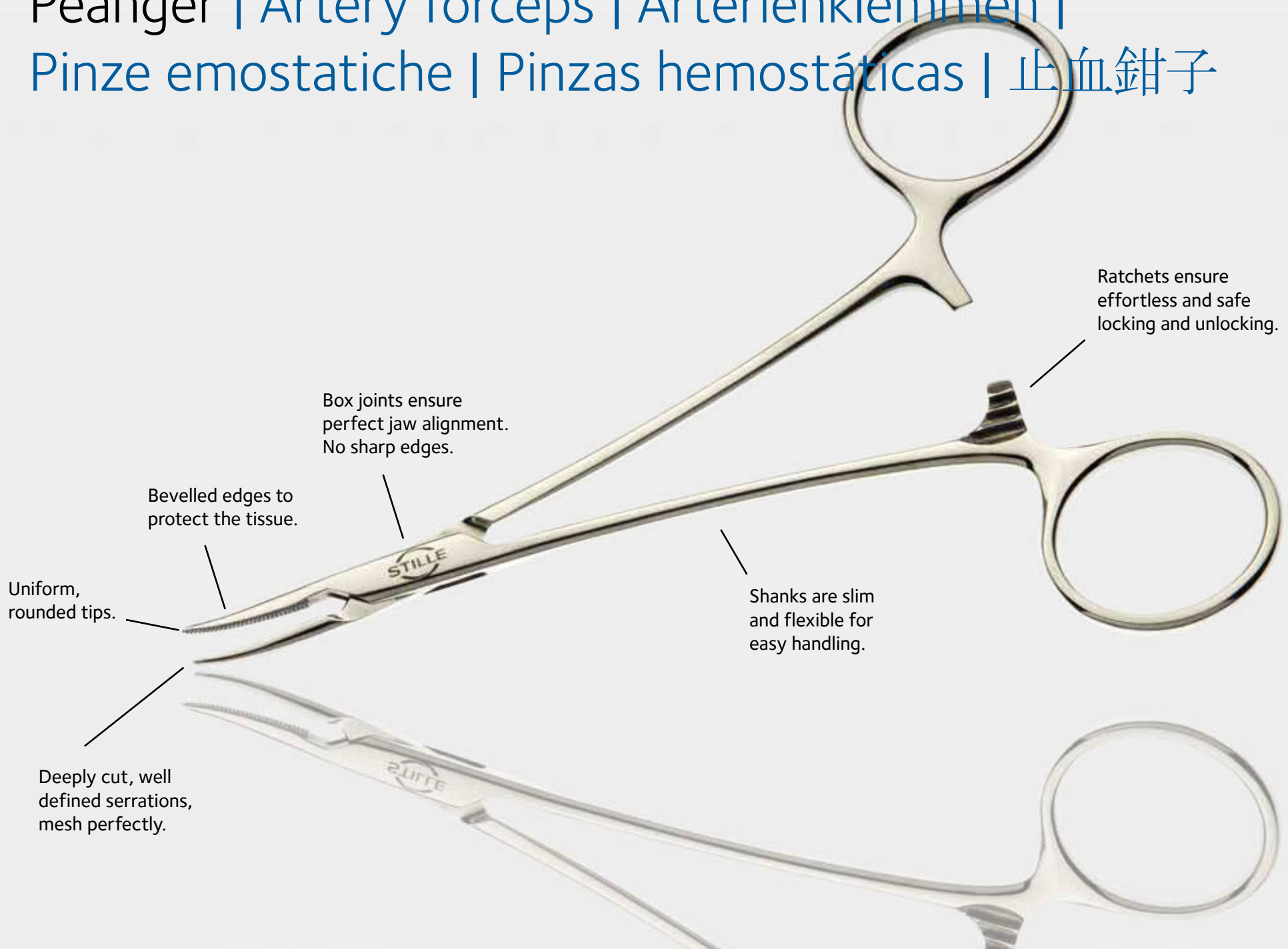

Ratchets ensure effortless and safe locking and unlocking.

Box joints ensure perfect jaw alignment. No sharp edges.

Bevelled edges to protect the tissue.

Uniform, rounded tips.

Shanks are slim and flexible for easy handling.

Deeply cut, well defined serrations, mesh perfectly.



### Pean STILLE peang | Pean STILLE Artery Forceps

General utility forceps used in many surgical disciplines.

|               |          |               |
|---------------|----------|---------------|
| 103-10015-131 | Straight | 13.5 cm 5.25" |
|---------------|----------|---------------|

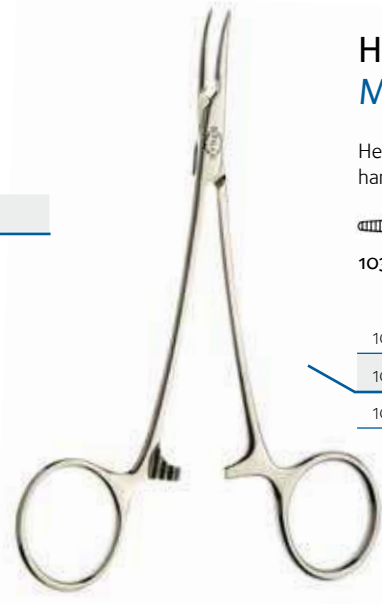

### Halsted-Mosquito STILLE peang | Halsted-Mosquito STILLE Artery Forceps

Hemostat without teeth, used in small operative fields. For plastic surgery, neuro, hand or any delicate surgery.

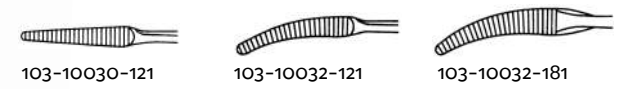

|               |               |               |
|---------------|---------------|---------------|
| 103-10030-121 | 103-10032-121 | 103-10032-181 |
| 103-10030-121 | Straight      | 12 cm 4.75"   |
| 103-10032-121 | Curved        | 12 cm 4.75"   |
| 103-10032-181 | Curved        | 18 cm 7"      |



### Halsted-Mosquito STILLE gracil peang | Halsted-Mosquito STILLE delicate Artery Forceps

Delicate hemostat without teeth for small operating field.



|               |               |             |
|---------------|---------------|-------------|
| 103-10026-121 | 103-10028-121 |             |
| 103-10026-121 | Straight      | 12 cm 4.75" |
| 103-10028-121 | Curved        | 12 cm 4.75" |

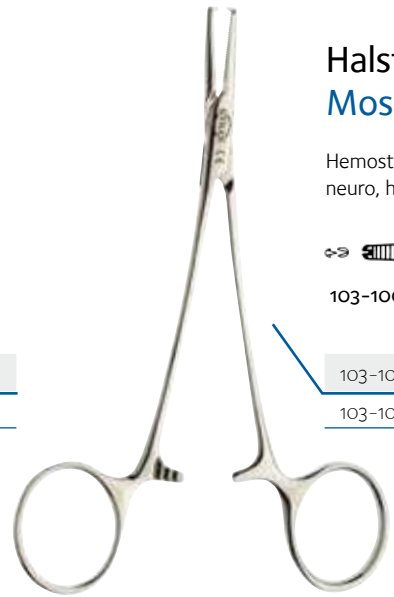

### Halsted-Mosquito STILLE peang | Halsted-Mosquito STILLE Artery Forceps

Hemostat with 1x2 teeth, used in small operative fields. For plastic surgery, neuro, hand or any delicate surgery.

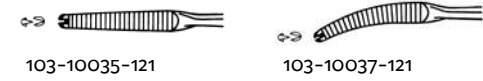

|               |               |          |             |
|---------------|---------------|----------|-------------|
| 103-10035-121 | 103-10037-121 |          |             |
| 103-10035-121 | 1x2 teeth     | Straight | 12 cm 4.75" |
| 103-10037-121 | 1x2 teeth     | Curved   | 12 cm 4.75" |

### Kocher STILLE peang | Kocher STILLE Artery Forceps

Hemostat with 1x2 teeth. Widely used when a short instrument is needed. Can also be used as tissue forceps to retract or lift an organ.



103-10115-141

|               |           |          |            |
|---------------|-----------|----------|------------|
| 103-10115-141 | 1x2 teeth | Straight | 14 cm 5.5" |
| 103-10117-141 | 1x2 teeth | Curved   | 14 cm 5.5" |



### Kelly STILLE peang | Kelly STILLE Artery Forceps

Fairly short hemostat with jaws, half-serrated.

|               |          |            |
|---------------|----------|------------|
| 103-10150-141 | Straight | 14 cm 5.5" |
| 103-10152-141 | Curved   | 14 cm 5.5" |





**Kelly-Rankin STILLE peang | Kelly-Rankin STILLE Artery Forceps**

Longer version of the Kelly hemostat with jaws half-serrated.

|               |          |             |
|---------------|----------|-------------|
| 103-10160-161 | Straight | 16 cm 6.25" |
| 103-10162-161 | Curved   | 16 cm 6.25" |

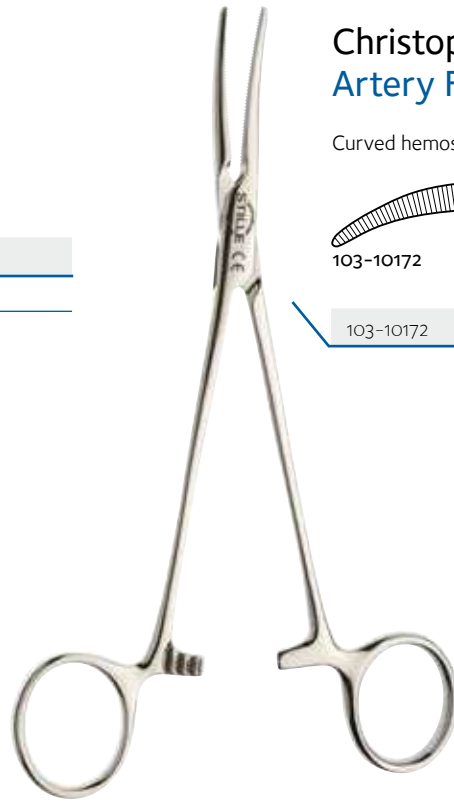

**Christophe-STILLE peang | Christophe-STILLE Artery Forceps**

Curved hemostat without teeth.



103-10172

|           |        |             |
|-----------|--------|-------------|
| 103-10172 | Curved | 16 cm 6.25" |
|-----------|--------|-------------|

### Crile STILLE peang | Crile STILLE Artery Forceps

General purpose hemostat without teeth. Used in relatively small operating fields, when more strength is needed than a Mosquito can offer.

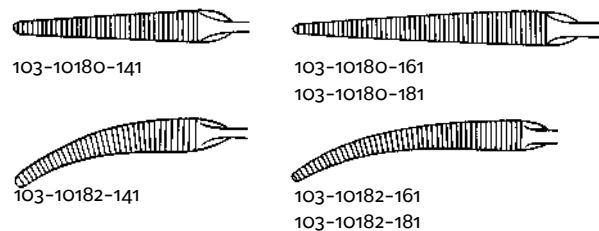

|               |          |             |
|---------------|----------|-------------|
| 103-10180-141 | Straight | 14 cm 5.5"  |
| 103-10180-161 | Straight | 16 cm 6.25" |
| 103-10180-181 | Straight | 18 cm 7"    |
| 103-10182-141 | Curved   | 14 cm 5.5"  |
| 103-10182-161 | Curved   | 16 cm 6.25" |
| 103-10182-181 | Curved   | 18 cm 7"    |



### Crile STILLE peang | Crile STILLE Artery Forceps

General purpose hemostat with 1x2 teeth. Used in relatively small operating fields, when more strength is needed than a Mosquito can offer.

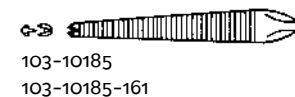

|               |           |          |             |
|---------------|-----------|----------|-------------|
| 103-10185     | 1x2 teeth | Straight | 14 cm 5.5"  |
| 103-10185-161 | 1x2 teeth | Straight | 16 cm 6.25" |
| 103-10187-141 | 1x2 teeth | Curved   | 14 cm 5.5"  |
| 103-10187-161 | 1x2 teeth | Curved   | 16 cm 6.25" |



### Leriche STILLE peang | Leriche STILLE Artery Forceps

Fairly tapered hemostat. For use in small operative fields.

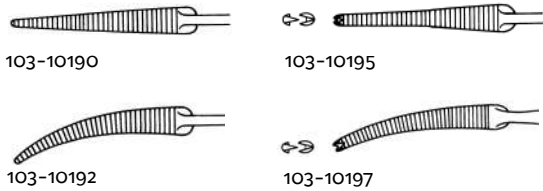

|           |           |          |          |
|-----------|-----------|----------|----------|
| 103-10190 |           | Straight | 15 cm 6" |
| 103-10192 |           | Curved   | 15 cm 6" |
| 103-10195 | 1x2 teeth | Straight | 15 cm 6" |
| 103-10197 | 1x2 teeth | Curved   | 15 cm 6" |



### Rochester-Péan STILLE peang | Rochester-Péan STILLE Artery Forceps

Sturdy hemostat. Relatively blunt tips. Used in all types of surgery.

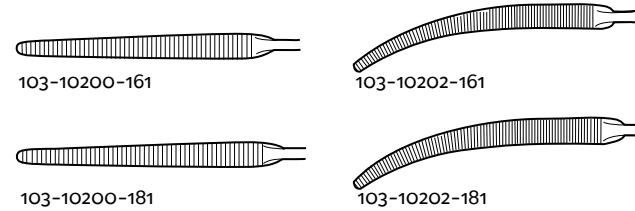

|               |  |          |             |
|---------------|--|----------|-------------|
| 103-10200-161 |  | Straight | 16 cm 6.25" |
| 103-10200-181 |  | Straight | 18 cm 7"    |
| 103-10202-161 |  | Curved   | 16 cm 6.25" |
| 103-10202-181 |  | Curved   | 18 cm 7"    |



### Rochester-Ochsner STILLE peang | Rochester-Ochsner STILLE Artery Forceps

Sturdy hemostat with 1x2 teeth. Used when a strong forceps is needed, both to occlude blood vessels and to lift or retract organs.

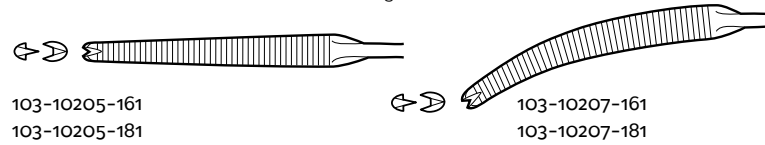

103-10205-161  
103-10205-181

103-10207-161  
103-10207-181

|               |           |          |             |
|---------------|-----------|----------|-------------|
| 103-10205-161 | 1x2 teeth | Straight | 16 cm 6.25" |
| 103-10205-181 | 1x2 teeth | Straight | 18 cm 7"    |
| 103-10207-161 | 1x2 teeth | Curved   | 16 cm 6.25" |
| 103-10207-181 | 1x2 teeth | Curved   | 18 cm 7"    |



### Rochester-Péan STILLE peang | Rochester-Péan STILLE Artery Forceps

Sturdy hemostats. The 20 cm has short and the 24 cm has long jaws. Also referred to as hysterectomy forceps.

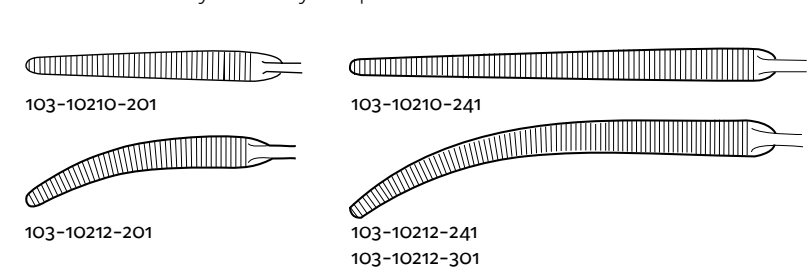

103-10210-201

103-10210-241

103-10212-201

103-10212-241  
103-10212-301

|               |          |            |
|---------------|----------|------------|
| 103-10210-201 | Straight | 20 cm 8"   |
| 103-10210-241 | Straight | 24 cm 9.5" |
| 103-10212-201 | Curved   | 20 cm 8"   |
| 103-10212-241 | Curved   | 24 cm 9.5" |
| 103-10212-301 | Curved   | 30 cm 12"  |



### Rochester-Ochsner STILLE peang | Rochester-Ochsner STILLE Artery Forceps

Sturdy hemostat with 1x2 teeth. Used when a strong and long forceps is needed, both to occlude blood vessels and to lift or retract organs.

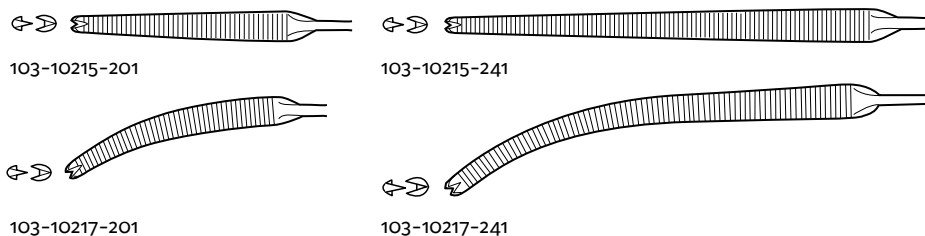

|               |           |          |            |
|---------------|-----------|----------|------------|
| 103-10215-201 | 1x2 teeth | Straight | 20 cm 8"   |
| 103-10215-241 | 1x2 teeth | Straight | 24 cm 9.5" |
| 103-10217-201 | 1x2 teeth | Curved   | 20 cm 8"   |
| 103-10217-241 | 1x2 teeth | Curved   | 24 cm 9.5" |



### Bengolea STILLE peang | Bengolea STILLE Artery Forceps

A long hemostat with straight or curved jaws without teeth.

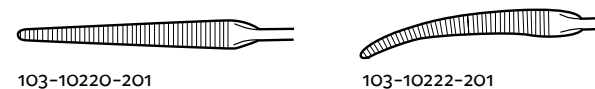

|               |          |          |
|---------------|----------|----------|
| 103-10220-201 | Straight | 20 cm 8" |
| 103-10222-201 | Curved   | 20 cm 8" |





### Olivecrona STILLE peang | Olivecrona STILLE Artery Forceps

16 cm straight hemostat. Useful as a long hemostat with fine points.



103-10240-161

|               |          |             |
|---------------|----------|-------------|
| 103-10240-161 | Straight | 16 cm 6.25" |
|---------------|----------|-------------|



### Adson STILLE peang | Adson STILLE Artery Forceps

Popular model when a little longer and fairly delicate hemostat is needed.

|               |          |            |
|---------------|----------|------------|
| 103-10260-191 | Straight | 19 cm 7.5" |
| 103-10262-191 | Curved   | 19 cm 7.5" |



### Dandy STILLE peang | Dandy STILLE Artery Forceps

Side curved hemostat without teeth. Often used in neuro surgery.



103-10310

103-10310 14 cm 5.5"



### Schmidt STILLE peang | Schmidt STILLE Artery Forceps

A hemostat popular in general surgery.



103-10411-201

103-10411-201 Curved 20 cm 8"



## Sawtell STILLE peang | Sawtell STILLE Artery Forceps

A hemostat with half-serrated and fairly strongly curved jaws.

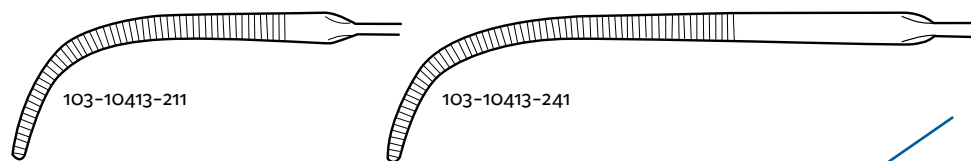

|               |        |             |
|---------------|--------|-------------|
| 103-10413-211 | Curved | 21 cm 8.25" |
| 103-10413-241 | Curved | 24 cm 9.5"  |



### Heiss STILLE peang | Heiss STILLE Artery Forceps

Dissecting and ligature clamps with half-serrated, jaws.

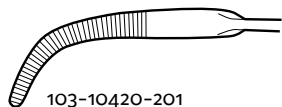

|               |                 |             |
|---------------|-----------------|-------------|
| 103-10421-211 | Straight        | 21 cm 8.25" |
| 103-10422-211 | Curved          | 21 cm 8.25" |
| 103-10420-201 | Strongly curved | 20 cm 8"    |



### Overholt STILLE peang | Overholt STILLE Dissecting Forceps

Strongly curved dissecting forceps.

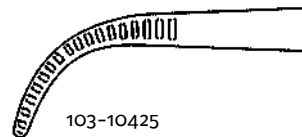

|           |                 |            |
|-----------|-----------------|------------|
| 103-10425 | Strongly curved | 14 cm 5.5" |
|-----------|-----------------|------------|



## Crafoord STILLE peang | Crafoord STILLE Artery Forceps

Designed for thoracic and cardiovascular surgery. The fine tips make this a very useful instrument. Offers the surgeon Mosquito type tips, but with a length that allows working in a deep cavity.

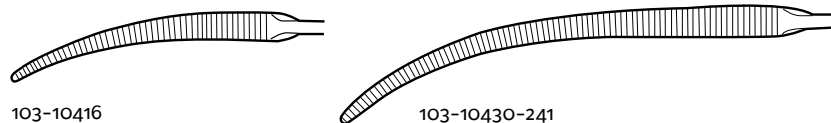

|               |        |            |
|---------------|--------|------------|
| 103-10416     | Curved | 18 cm 7"   |
| 103-10430-241 | Curved | 24 cm 9.5" |



### STILLE artär- och ligaturklämmare | STILLE Artery and Ligature Clamp

Four very delicate models of dissecting forceps with different jaw curvature.

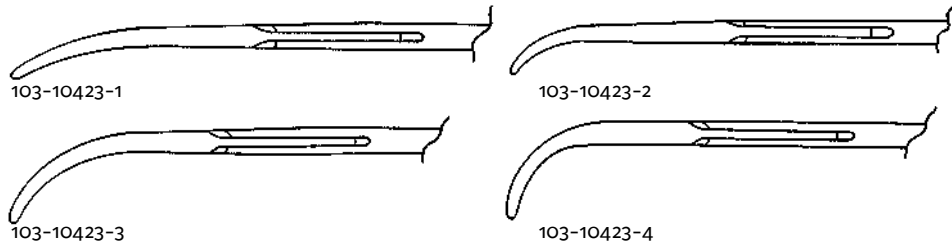

|             |                 |               |
|-------------|-----------------|---------------|
| 103-10423-1 | Slightly curved | 20 cm 8"      |
| 103-10423-2 | Curved          | 20 cm 8"      |
| 103-10423-3 | Strongly curved | 19,5 cm 7.75" |
| 103-10423-4 | Angled 90°      | 19 cm 7,5"    |



### STILLE-Ehrén ligaturklämmare | STILLE-Ehrén Ligature Clamp

For fine and precise handling of ligatures in very narrow areas, such as paediatric surgery. The jaws close only at the tips to minimize the risk for accidental clamping of fragile vessels etc. Developed together with Henrik Ehrén, M.D. at Karolinska University Hospital. Matted finish.

103-10428-151 Delicate Strongly curved 15 cm 6"







**FÖR ETT FULLGOTT RESULTAT VID SUTURERING** krävs ett pålitligt och tåligt instrument. STILLES nålförare känns lätt igen på den gracila och mjuka designen vilket hjälper kirurgen att hålla nålen i ett mycket säkert grepp. De gyllene fingeröglorna indikerar att käftarna är försedda med inlägg av hårdmetall vilket förlänger hållbarheten. Vissa nålförare är istället belagda med Diamond Jaws där hårdmetallen har sprutats på som ett tunt skikt på insidan av käftarna.

Ett annat säkert kännetecken för STILLES nålförare är det öppna boxlåset vilket minskar risken för att nålföraren ska fastna i suturen eller kirurgens handskar. Samtidigt förenklas rengöring och sterilisering. Knäppets unika utformning ser till att nålföraren hålls stängd i ett säkert läge samtidigt som den är enkel att öppna igen. Alla dessa egenskaper ligger bakom den där speciella känslan som instrument från STILLE ger.

För exakt matchning av suturer och nålförare, se separat guide för passande suturstorlek till varje nålförare.



**A PERFECT RESULT WHEN SUTURING** requires a reliable and durable instrument. STILLE needle holders are easily recognized by their delicate and soft design, which helps the surgeon to hold the needle very securely. The golden finger loops indicate that the jaws are fitted with inserts of hard metal, which prolongs the life of the instrument. Some needle holders are instead coated with Diamond Jaws where hard metal is sprayed on as a thin layer on the inside of the jaws.

Another feature of STILLE's needle holders is the open box lock. This reduces the risk of the needle holder being caught in the sutures or the surgeon's gloves. It also simplifies the cleaning and sterilization process. The ratchet's unique design ensures that the instrument stays closed in a safe position while remaining easy to open. All of these features are characteristic of that special feel that instruments from STILLE provide.

For precise matching of sutures and needle holders, see the separate guide for matching suture size to individual needle holders.



# Nålförare | Needle holders | Nadelhalter | Portaghi | Porta-agujas | 持針器

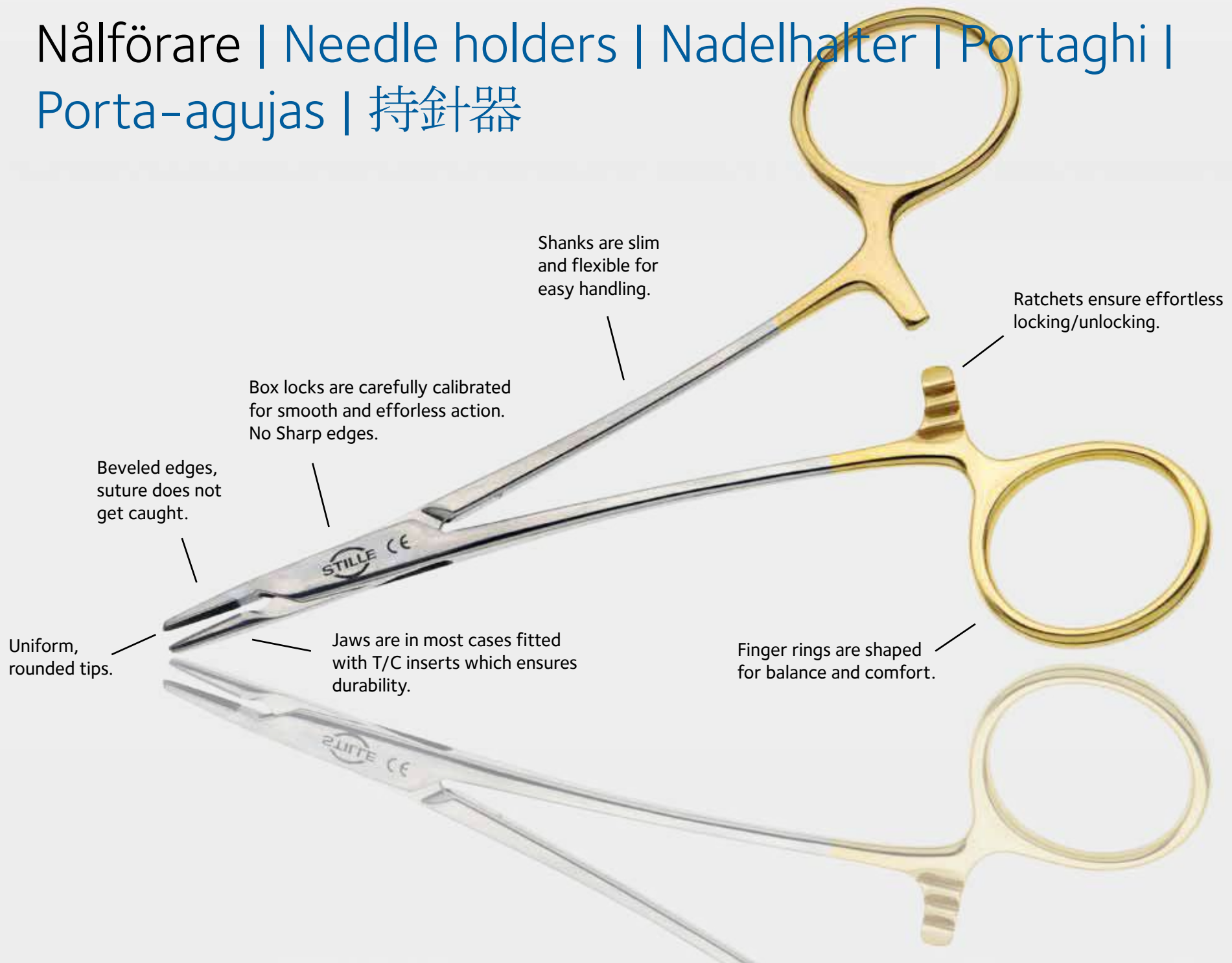



| Art.no        | Description  | Max suture size |
|---------------|--|-----------------|
| 104-15542     | RAPP-STILLE KNOT-HOLDING FORCEPS 13 cm 5"              | 3/0             |
| 104-15545     | WEBSTER STILLE very delicate DD jaws 12 cm 4.75"       | 5/0             |
| 104-15546     | WEBSTER STILLE very delicate smooth 12 cm 4.75"        | 5/0             |
| 104-15549-131 | KILNER STILLE TC jaws 13 cm 5"                         | 4/0             |
| 104-15550     | GILLIES STILLE serrated 16 cm 6.25"                    | 2/0             |
| 104-15551     | GILLIES STILLE TC jaws 16 cm 6.25"                     | 2/0             |
| 104-15556     | WEBSTER STILLE delicate smooth 12 cm 4.75"             | 4/0             |
| 104-15557     | WEBSTER-KLEINERT STILLE smooth offset bows 12 cm 4.75" | 4/0             |
| 104-15558     | WEBSTER STILLE smooth TC jaws 12 cm 4.75"              | 3/0             |
| 104-15559     | WEBSTER STILLE serrated TC jaws 12 cm 4.75"            | 4/0             |
| 104-15560     | HALSEY STILLE TC jaws 12.5 cm 5"                       | 3/0             |
| 104-15560-2   | HALSEY STILLE ERGONOMIC TC jaws 12.5 cm 5"             | 3/0             |
| 104-15561-141 | MAYO-HEGAR STILLE TC jaws 14 cm 5.5"                   | 0               |
| 104-15561-161 | MAYO-HEGAR STILLE TC jaws 16 cm 6.25"                  | 0               |
| 104-15561-181 | MAYO-HEGAR STILLE TC jaws 18 cm 7"                     | 0               |
| 104-15561-201 | MAYO-HEGAR STILLE TC jaws 20 cm 8"                     | 0               |
| 104-15561-251 | MAYO-HEGAR STILLE TC jaws 25 cm 10"                    | 0               |
| 104-15562-161 | MAYO-HEGAR STILLE Heavy Pattern TC jaws 16 cm 6.25"    | 1               |
| 104-15562-181 | MAYO-HEGAR STILLE Heavy Pattern TC jaws 18 cm 7"       | 1               |
| 104-15562-201 | MAYO-HEGAR STILLE Heavy Pattern TC jaws 20 cm 8"       | 1               |
| 104-15562-241 | MAYO-HEGAR STILLE Heavy Pattern TC jaws 24 cm 9.5"     | 1               |
| 104-15562-271 | MAYO-HEGAR STILLE Heavy Pattern TC jaws 27 cm 10.5"    | 1               |
| 104-15562-301 | MAYO-HEGAR STILLE Heavy Pattern TC jaws 30 cm 12"      | 1               |
| 104-15565-151 | CRILE-WOOD STILLE TC jaws 15 cm 6"                     | 2/0             |
| 104-15565-181 | CRILE-WOOD STILLE TC jaws 18 cm 7"                     | 2/0             |
| 104-15565-201 | CRILE-WOOD STILLE TC jaws 20 cm 8"                     | 2/0             |
| 104-15565-231 | CRILE-WOOD STILLE TC jaws 23 cm 9"                     | 2/0             |

| Art.no        | Description  | Max suture size |
|---------------|--|-----------------|
| 104-15566-151 | BABY CRILE-WOOD STILLE delicate TC 15 cm 6"            | 3/0             |
| 104-15566-181 | CRILE-WOOD STILLE delicate TC jaws 18 cm 7"            | 3/0             |
| 104-15566-201 | CRILE-WOOD STILLE delicate TC jaws 20 cm 8"            | 3/0             |
| 104-15566-231 | CRILE-WOOD STILLE delicate TC jaws 23 cm 9"            | 3/0             |
| 104-15571     | NEW ORLEANS STILLE TC jaws 18 cm 7"                    | 3/0             |
| 104-15573-161 | RYDER STILLE TC jaws 16 cm 6.25"                       | 3/0             |
| 104-15573-181 | RYDER STILLE TC jaws 18 cm 7"                          | 3/0             |
| 104-15573-201 | RYDER STILLE TC jaws 20 cm 8"                          | 3/0             |
| 104-15585-161 | STILLE DD jaws 16 cm 6.25"                             | 4/0             |
| 104-15585-181 | STILLE DD jaws 18.5 cm 7.5"                            | 4/0             |
| 104-15585-221 | STILLE DD jaws 22 cm 8.75"                             | 4/0             |
| 104-15585-251 | STILLE DD jaws 25 cm 10"                               | 4/0             |
| 104-15586     | STILLE TC jaws 18 cm 7"                                | 4/0             |
| 104-15590-121 | OLSEN-HEGAR STILLE TC jaws with scissors 12 cm 4.75"   | 3/0             |
| 104-15590-131 | OLSEN-HEGAR STILLE TC jaws with scissors 13.5 cm 5.25" | 2/0             |
| 104-15590-171 | OLSEN-HEGAR STILLE TC jaws with scissors 17 cm 6.75"   | 0               |
| 104-15590-181 | OLSEN-HEGAR STILLE TC jaws with scissors 18.5 cm 7.25" | 0               |
| 104-15621-179 | MATHIEU STILLE TC jaws 17 cm 6.75"                     | 1               |
| 104-15621-209 | MATHIEU STILLE TC jaws 18.5 cm 7.25"                   | 1               |
| 104-15665-151 | Frimand-STILLE DUO-GRIP Needle holder TC jaws 15 cm 6" | 2/0             |
| 104-15777     | KAYE STILLE with scissors serrated TC jaws 12 cm 4.75" | 5/0             |
| 104-15785     | CONVERSE STILLE TC jaws 10.5 cm 4.25"                  | 4/0             |

Suture size indicates the largest recommended for each needle holder.

### Derf STILLE nålförare | Derf STILLE Needle holder

Needle holder with rather short TC jaws, popular in plastic surgery. Intended for 3/0 suture and finer.



104-15542

104-15542 TC jaws 12 cm 4.75"



### Webster STILLE nålförare | Webster STILLE Needle holder

Very delicate needle holder for very fine sutures. Smooth jaws or DD jaws. Intended for 5/0 suture and finer.



104-15545



104-15546

104-15545 Very delicate DD jaws 12 cm 4.75"

104-15546 Very delicate Smooth 12 cm 4.75"

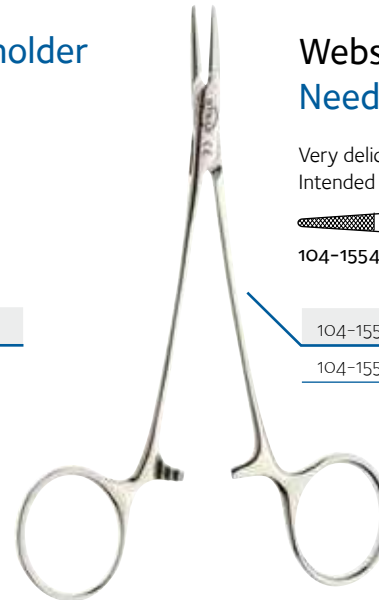

### Kilner STILLE nålförare | Kilner STILLE Needle holder

Delicate needleholder with bayonet shaped shanks. TC jaws. Intended for 4/0 suture and finer.

104-15549-131 13 cm 5"



## Gillies STILLE nålförare | Gillies STILLE Needle Holder

Needle holder with scissors. Ergonomic design on shanks and finger rings. One rather large ring handle is set at an angle for fitting the top of the thumb. Without ratchets. With or without TC jaws. The scissor part enables suturing and cutting with one instrument. Intended for 2/0 suture and finer.

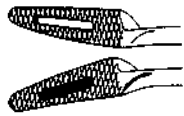

104-15550



104-15551

|           |               |         |             |
|-----------|---------------|---------|-------------|
| 104-15550 | With scissors |         | 16 cm 6.25" |
| 104-15551 | With scissors | TC jaws | 16 cm 6.25" |



## Webster/Kleinert STILLE nålförare | Webster/Kleinert STILLE Needle holder

Delicate needle holder for fine needles. With smooth jaws or TC jaws. The Webster-Kleinert (104-15557) has offset bows for a comfortable grip. Intended for 4/0 suture and finer.

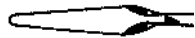

104-15556

104-15557



104-15559

|           |             |         |             |
|-----------|-------------|---------|-------------|
| 104-15556 | Delicate    | Smooth  | 12 cm 4.75" |
| 104-15557 | Offset bows | Smooth  | 12 cm 4.75" |
| 104-15559 | Serrated    | TC jaws | 12 cm 4.75" |



## Webster STILLE nålförare | Webster STILLE Needle holder

Delicate needle holder for fine needles. With smooth TC jaws. Intended for 3/0 suture and finer.



104-15558

|           |        |         |             |
|-----------|--------|---------|-------------|
| 104-15558 | Smooth | TC jaws | 12 cm 4.75" |
|-----------|--------|---------|-------------|

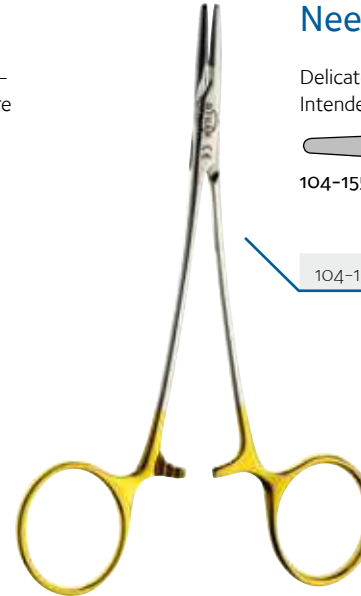



### Halsey STILLE nålförare | Halsey STILLE Needle Holder

Needle holder with TC jaws used in many procedures. One model with ergonomically designed finger ring for thumb. For slightly larger needles than the Webster needle holder. Intended for 3/0 suture and finer.



104-15560

|                       |         |            |
|-----------------------|---------|------------|
| 104-15560             | TC jaws | 12.5 cm 5" |
| 104-15560-2 Ergonomic | TC jaws | 12.5 cm 5" |

### Mayo-Hegar STILLE nålförare | Mayo-Hegar STILLE Needle holder

Commonly used general purpose needle holder with TC jaws. Intended for 0 suture and finer.



104-15561

|               |         |             |
|---------------|---------|-------------|
| 104-15561-141 | TC jaws | 14 cm 5.5"  |
| 104-15561-161 | TC jaws | 16 cm 6.25" |
| 104-15561-181 | TC jaws | 18 cm 7"    |
| 104-15561-201 | TC jaws | 20 cm 8"    |
| 104-15561-251 | TC jaws | 25 cm 10"   |



### Mayo-Hegar STILLE kraftig nålförare | Mayo-Hegar STILLE Heavy Needle holder

Heavier version of the widely used Mayo-Hegar needle holder, with TC jaws. Intended for 1 suture and finer.

|               |               |         |               |
|---------------|---------------|---------|---------------|
| 104-15562-161 | Heavy Pattern | TC jaws | 16 cm 6.25"   |
| 104-15562-181 | Heavy Pattern | TC jaws | 18.5 cm 7.25" |
| 104-15562-201 | Heavy Pattern | TC jaws | 20.5 cm 8"    |
| 104-15562-241 | Heavy Pattern | TC jaws | 24 cm 9.5"    |
| 104-15562-271 | Heavy Pattern | TC jaws | 27 cm 10.75"  |
| 104-15562-301 | Heavy Pattern | TC jaws | 30.5 cm 12"   |

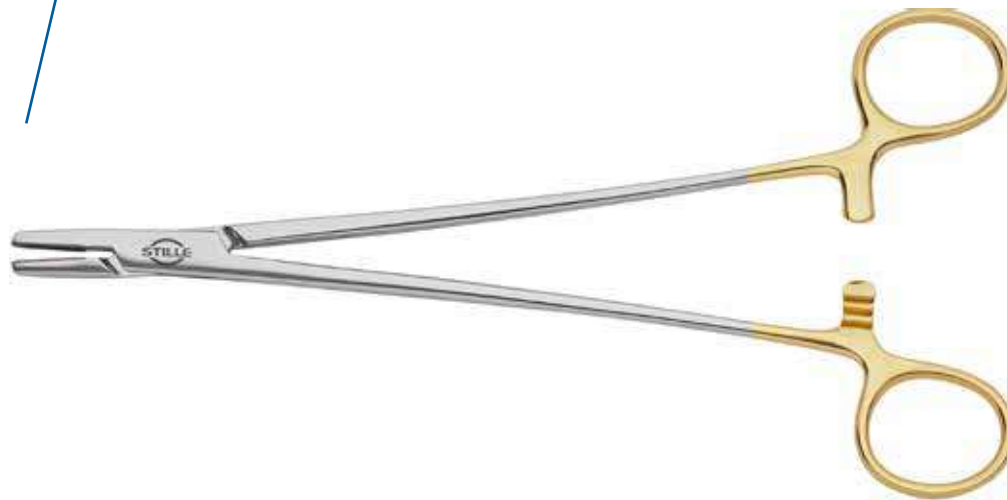

### STILLE Crile-Wood nålförare | STILLE Crile-Wood Needle holder

General purpose needle holder with TC jaws. Intended for 2/0 suture and finer.



104-15565

|               |                    |
|---------------|--------------------|
| 104-15565-151 | TC jaws 15 cm 6 in |
| 104-15565-181 | TC jaws 18 cm 7 in |
| 104-15565-201 | TC jaws 20 cm 8 in |
| 104-15565-231 | TC jaws 23 cm 9 in |



### Crile-Wood STILLE gracil nålförare | Crile-Wood STILLE Delicate Needle holder

Delicate version of the popular Crile-Wood needle holder. With TC jaws. Intended for 3/0 suture and finer.



104-15566

|               |          |         |          |
|---------------|----------|---------|----------|
| 104-15566-151 | Delicate | TC jaws | 15 cm 6" |
| 104-15566-181 | Delicate | TC jaws | 18 cm 7" |
| 104-15566-201 | Delicate | TC jaws | 20 cm 8" |
| 104-15566-231 | Delicate | TC jaws | 23 cm 9" |



### STILLE-Frimand DUO-GRIP nålförare | STILLE-Frimand DUO-GRIP Needle holder

Designed in cooperation with Carl-Fredrik Frimand, M.D. Intended for precise use in the palmar grip without the need of grip change during suturing. This new and innovative needle holder reduces the suturing time and tissue manipulation as well as offering better ergonomics for the surgeon. Intended for 2/0 suture and finer.



104-15665-151

|               |         |          |
|---------------|---------|----------|
| 104-15665-151 | TC jaws | 15 cm 6" |
|---------------|---------|----------|



### New Orleans STILLE nålförare | New Orleans STILLE Needle holder

Short tapered TC jaws, one jaw straight serrated and the other cross-serrated.  
Intended for 3/0 suture and finer.



104-15571

|           |         |          |
|-----------|---------|----------|
| 104-15571 | TC jaws | 18 cm 7" |
|-----------|---------|----------|



### Ryder STILLE nålförare | Ryder STILLE Needle holder

Needle holder with very narrow, non-tapered, serrated TC jaws. Popular in vascular surgery. Intended for 3/0 suture and finer.



104-15573

|               |         |             |
|---------------|---------|-------------|
| 104-15573-161 | TC jaws | 16 cm 6.25" |
| 104-15573-181 | TC jaws | 18 cm 7"    |
| 104-15573-201 | TC jaws | 20 cm 8"    |





### STILLE nålförare | STILLE Needle holder

TC-sprayed delicate jaws. Intended for 4/0 suture and finer.

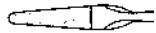

104-15585

|               |         |              |
|---------------|---------|--------------|
| 104-15585-161 | DD jaws | 16 cm 6.25"  |
| 104-15585-181 | DD jaws | 18.5 cm 7.5" |
| 104-15585-221 | DD jaws | 22 cm 8.75"  |
| 104-15585-251 | DD jaws | 25 cm 10"    |

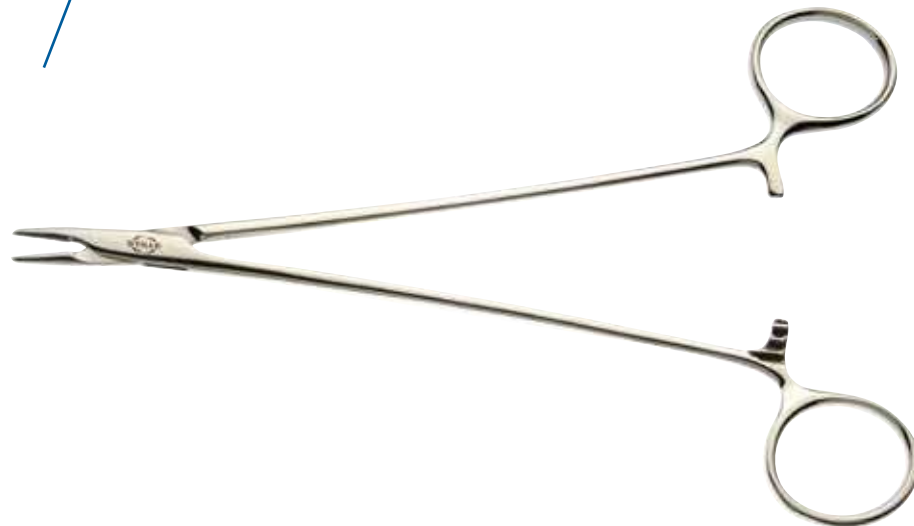

### STILLE nålförare | STILLE Needle holder

Delicate needle holder with TC jaws. Intended for 4/0 suture and finer.



104-15586

|           |         |          |
|-----------|---------|----------|
| 104-15586 | TC jaws | 18 cm 7" |
|-----------|---------|----------|



### Olsen-Hegar STILLE nålförare | Olsen-Hegar STILLE Needle holder

Popular needle holder with scissors for suturing and cutting with the same instrument. Intended for 0 suture and finer. See table "Needle holder in relation to suture size" for suitable suture size for each article code. 3+3 ratchets, 104-15590-171 has 2+2 ratchets.

|               |          |               |
|---------------|----------|---------------|
| 104-15590-121 | Scissors | 12 cm 4.75"   |
| 104-15590-131 | Scissors | 13.5 cm 5.25" |
| 104-15590-171 | Scissors | 17 cm 6.75"   |
| 104-15590-181 | Scissors | 18.5 cm 7.25" |



### Mathieu STILLE nålförare | Mathieu STILLE Needle holder

Needle holder with straight TC jaws. Plier type handle with ratchets that allows the surgeon to open and close the needle holder rapidly. Intended for 1 suture and finer.



104-15621

|               |         |               |
|---------------|---------|---------------|
| 104-15621-179 | TC jaws | 17 cm 6.75"   |
| 104-15621-209 | TC jaws | 18.5 cm 7.25" |



### Kaye STILLE nålförare | Kaye STILLE Needle holder

Delicate needle holder with short, fine TC jaws and sharp scissors. The scissor part enables suturing and cutting with one instrument. Intended for 5/0 suture and finer.



104-15777

104-15777 Serrated TC jaws 12 cm 4.75"



### Converse STILLE nålförare | Converse STILLE Needle holder

Short and delicate needle holder for fine work. With TC jaws. Intended for 4/0 suture and finer.

104-15785 TC jaws 10.5 cm 4.75"



## Rapp-STILLE knuthållartång | Rapp-STILLE Knot-holding Forceps

A 13 cm knot-holding forceps with smooth jaws. Ideal instrument to use as a tool for holding the suture knot in narrow areas.

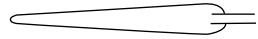

104-15140

104-15140 13 cm 5"



### STILLE ståltrådsroterare | STILLE Wire Twisting Forceps

A good tool for twisting steel wires. With TC jaws.

|           |            |               |
|-----------|------------|---------------|
| 104-15832 | TC-inserts | 15 cm 6"      |
| 104-15835 | TC-inserts | 18,5 cm 7.25" |

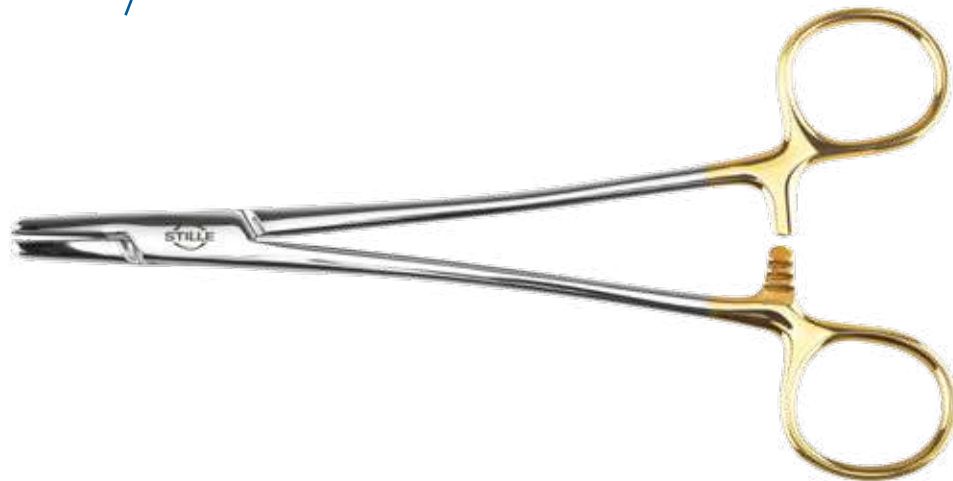

### STILLE ståltrådshållare | STILLE Wire Holding Forceps

For holding steel wires. Equipped with double-action joint and TC jaws. The jaws close parallel to secure a firm grip of the wire.

|           |        |          |
|-----------|--------|----------|
| 104-15854 | Fine   | 18 cm 7" |
| 104-15855 | Medium | 18 cm 7" |
| 104-15856 | Large  | 18 cm 7" |

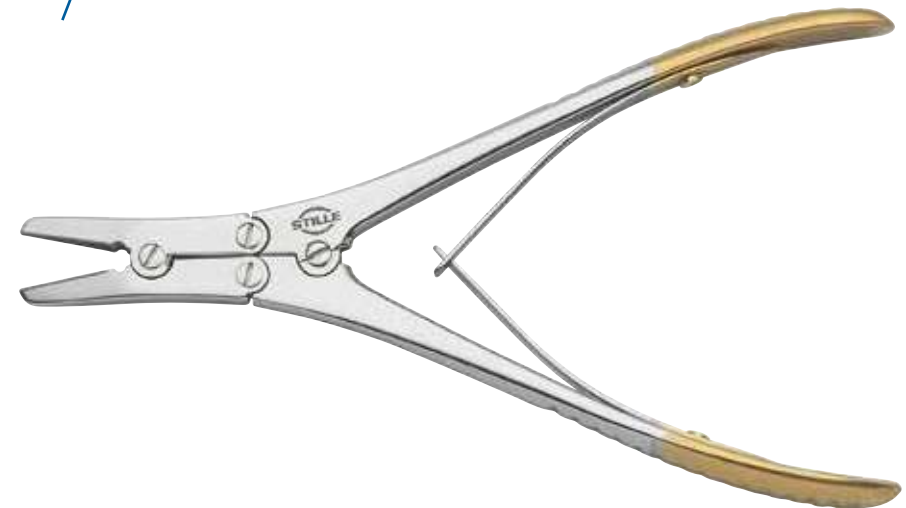



**THESE DOUBLE-ACTION BONE RONGEURS** allow the surgeon to gently and smoothly cut bone with one hand. STILLE invented this double-action solution as early as 1872 and since then, both our bone cutters and rongeurs have been widely imitated. But the original is always better than the imitation, and are perceived by many surgeons as more graceful and easier to use than any other brand.

Double-action bone rongeurs increase the force at the cutting surface when cutting bone with maximum leverage. The special design means that they do not obstruct the view of the operative area. They can be used for orthopaedics, neurosurgery and plastic surgery.

STILLE bone rongeurs are not riveted at the joints, but are assembled using precision screws instead. This means that they can be easily taken apart for sharpening and service, which prolongs the life of the instrument considerably. Choosing original STILLE bone rongeurs is a worthwhile investment and offers a unique feel and ultra precision.

**MED DUBBELLEDADE BENTÄNGER** går det att klippa i benvävnad med bara en hand, mjukt och smidigt. STILLE uppfann den dubbelledade lösningen redan 1872 och sedan dess har såväl våra benavbitare som gougetänger ofta kopierats. Men originalet är alltid bättre än kopian och upplevs av många kirurger som gracilare och enklare att använda än alla andra fabrikat.

Dubbelledade bentänger ökar kraften vid skärytan när man klipper i ben vid maximal utväxling. Bentängernas speciella utformning gör att de inte skymmer sikten i arbetet. De kan användas inom både ortopedi, neurokirurgi och plastikkirurgi.

STILLES bentänger är inte nitade i lederna utan istället monterade med precisionsskruvar. Det gör att de lätt kan tas isär vid slipning och service vilket förlänger instrumentens livslängd avsevärt. Att investera i en original STILLE bentång lönar sig samtidigt som instrumentet erbjuder en unik känsla och precision.



Bentänger | Bone cutters and rongeurs | Knochen & hohlmeisselzangen | Cesioie per ossa & pinze sgorbie | Pinzas cortantes & pinzas-gubias | 骨剪刀および骨鉗子(ロンジュール)

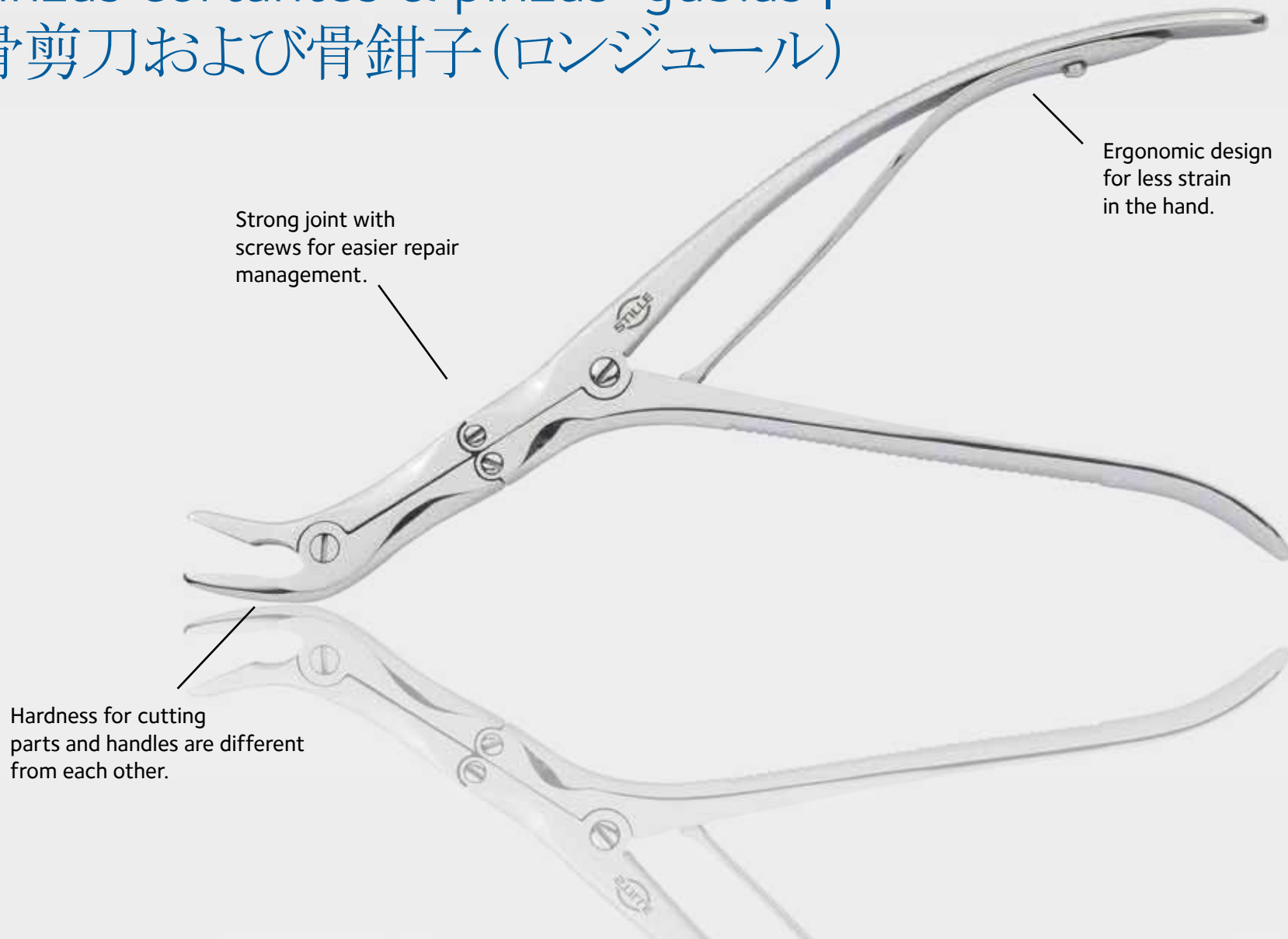

## STILLE plattång | STILLE Flat pliers

General purpose flat pliers with cross-serrated jaws.

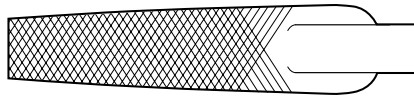

105-16015

105-16015 Cross-serrated 17 cm 6.75"





## STILLE extraktionstång | STILLE Extraction plier

Original STILLE double-action joint facilitates removal of pins and wires.



105-16020



105-16020-1

|             |             |            |
|-------------|-------------|------------|
| 105-16020   |             | 19 cm 7,5" |
| 105-16020-1 | Narrow jaws | 19 cm 7,5" |



### STILLE benavbitare | STILLE Bone Cutting Forceps

Bone cutting forceps with original STILLE double-action joint.

105-16510 Straight 17 cm 6.75"



### STILLE benavbitare | STILLE Bone Cutting Forceps

Delicate bone cutting forceps with original STILLE double-action joint.

105-16512 Angled 18 cm 7"



## STILLE benavbitare | STILLE Bone Cutting Forceps

Original STILLE double-action angled bone cutting forceps.

105-16811 Curved 19 cm 7.5"



## Beyer STILLE gougetång | Beyer STILLE Bone Rongeur

Nasal rongeur with curved, delicate jaws.



105-17030

|           |        |             |
|-----------|--------|-------------|
| 105-17030 | Curved | 17 cm 6.75" |
|-----------|--------|-------------|



### Beyer STILLE gougetång | Beyer STILLE Bone Rongeur

Bone rongeur with original STILLE double-action joint and two different jaw widths.



105-17210



105-17211

|           |        |          |          |
|-----------|--------|----------|----------|
| 105-17210 | Curved |          | 18 cm 7" |
| 105-17211 | Curved | Delicate | 18 cm 7" |



### Zaufal-Jansen STILLE gougetång | Zaufal-Jansen STILLE Bone Rongeur

Bone rongeur with original STILLE double-action joint and wide, curved jaws.



105-17215

|           |        |  |             |
|-----------|--------|--|-------------|
| 105-17215 | Curved |  | 17 cm 6.75" |
|-----------|--------|--|-------------|



### STILLE gougetång | STILLE Bone Rongeur

Bone rongeurs with STILLE double-action joint and two different jaw widths.



105-17216



105-17217

|           |               |        |          |
|-----------|---------------|--------|----------|
| 105-17216 |               | Curved | 15 cm 6" |
| 105-17217 | Delicate jaws | Curved | 15 cm 6" |



### Ruskin-STILLE gougetång | Ruskin-STILLE Bone Rongeur

Bone rongeur with original STILLE double-action joint and curved jaws.



105-17220

|           |  |        |            |
|-----------|--|--------|------------|
| 105-17220 |  | Curved | 19 cm 7.5" |
|-----------|--|--------|------------|



## Luer-STILLE gougetång | Luer-STILLE Bone Rongeur

Bone rongeur with original STILLE double-action joint and strongly curved wide jaws.

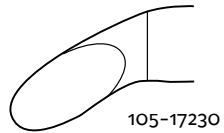

105-17230

105-17230 Curved 22 cm 8.75"



## STILLE gougetång | STILLE Bone Rongeur

Bone rongeur with original STILLE double-action joint and sideways curved jaws.

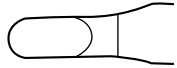

105-17250

105-17250 Curved 22 cm 8.75"





## Leksell STILLE gougetång | Leksell STILLE Bone Rongeur

Bone rongeur with original STILLE double-action joint and sideways slightly curved jaws.



105-17260



105-17261

|           |        |             |            |
|-----------|--------|-------------|------------|
| 105-17260 | Curved | Wide jaws   | 24 cm 9.5" |
| 105-17261 | Curved | Narrow jaws | 24 cm 9.5" |

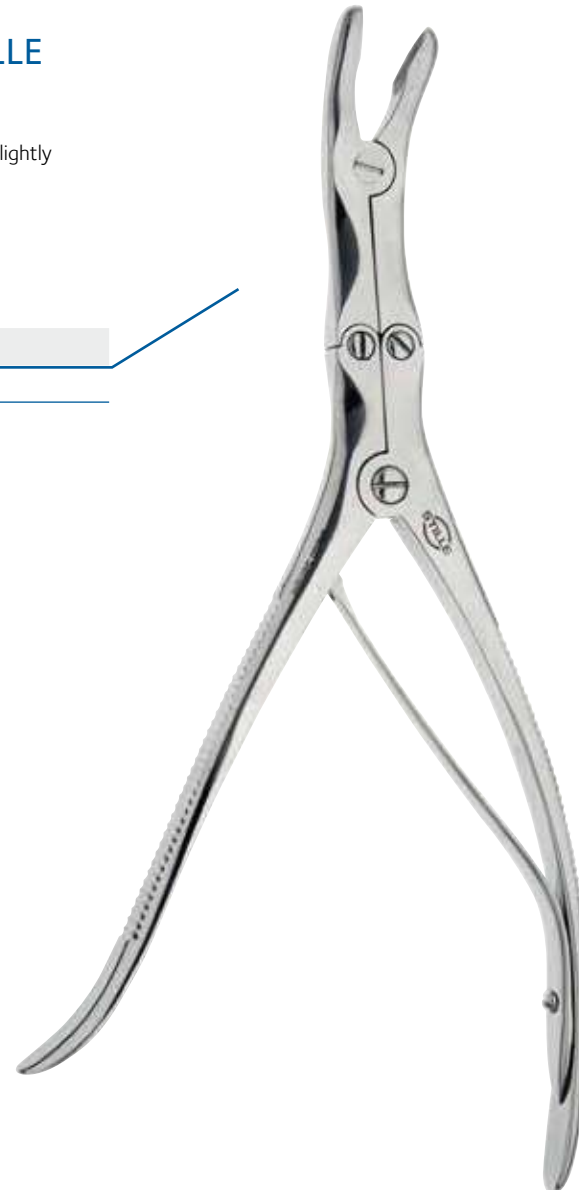

## Leksell STILLE gougetång | Leksell STILLE Bone Rongeur

Bone rongeur with original STILLE double-action joint and sideways strongly curved jaws.



105-17265



105-17266

|           |        |             |            |
|-----------|--------|-------------|------------|
| 105-17265 | Curved | Wide jaws   | 24 cm 9,5" |
| 105-17266 | Curved | Narrow jaws | 24 cm 9,5" |



## STILLE gougetång | STILLE Bone Rongeur

Bone rongeur with original STILLE double-action joint and sideways strongly curved jaws in different sizes.

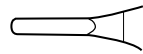

105-17267

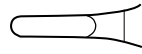

105-17268

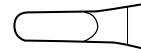

105-17269

|           |             |      |            |
|-----------|-------------|------|------------|
| 105-17267 | Curved jaws | 2 mm | 24 cm 9.5" |
| 105-17268 | Curved jaws | 3 mm | 24 cm 9.5" |
| 105-17269 | Curved jaws | 4 mm | 24 cm 9.5" |



**Semb STILLE benhållartång | Semb STILLE  
Bone Holding Forceps**

Bone holding forceps with or without locking mechanism.

|           |              |               |
|-----------|--------------|---------------|
| 105-16150 | Without lock | 19.5 cm 7.75" |
| 105-16152 | With lock    | 19.5 cm 7.75" |



### STILLE trådavbitare | STILLE Wire Cutter

Single joint wire cutter with TC-inserts. For hard wire up to 0.4 mm and soft wire up to 0.6 mm.

105-16215 TC inserts 12.5 cm 5"



### STILLE trådavbitare | STILLE Wire Cutter

Double joint wire cutter with TC-inserts. For hard wire up to 1.7 mm and soft wire up to 2.0 mm.

105-16223 TC inserts 17.5 cm 7"



## STILLE trådavbitare | STILLE Wire Cutter

Strong double joint wire cutter with TC-inserts. For hard wire up to 2.5 mm and soft wire up to 2.8 mm.

105-16225

TC inserts

22 cm 8.75"

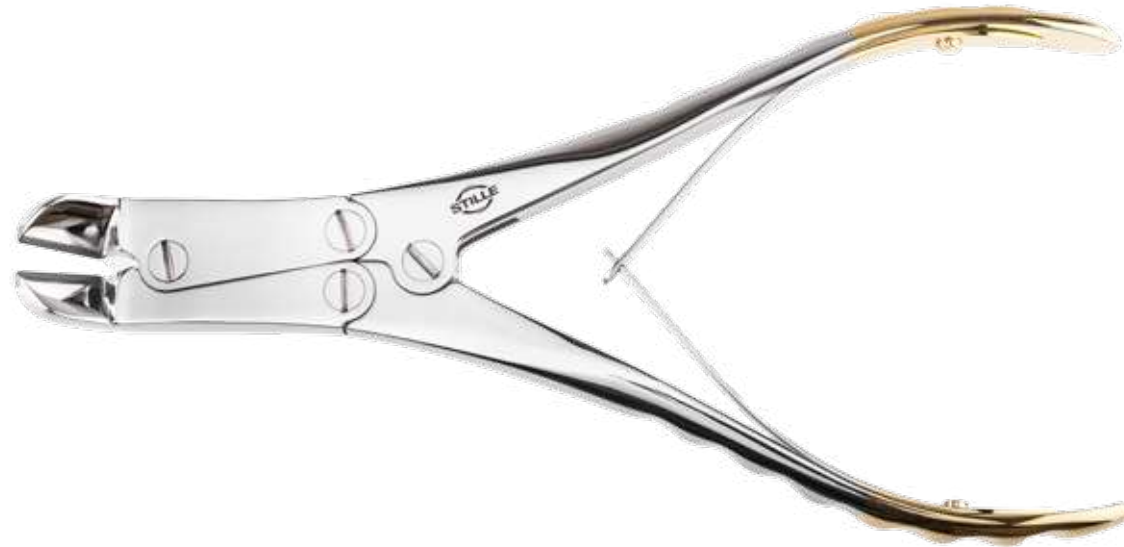

## Kerrison STILLE laminektomistans | Kerrison STILLE Laminectomy Punch

The popular Kerrison punches with a unique rubber coated handle for improved ergonomics. No spring between the handles improves the accessibility in cleaning and decreases the risk for getting caught with the gloves. All models come with ejector, 130° up cutting and thin footplate.

|             |          |      |
|-------------|----------|------|
| 105-17642-2 | 18 cm 7" | 2 mm |
| 105-17642-3 | 18 cm 7" | 3 mm |
| 105-17642-4 | 18 cm 7" | 4 mm |
| 105-17642-5 | 18 cm 7" | 5 mm |
| 105-17643-2 | 20 cm 8" | 2 mm |
| 105-17643-3 | 20 cm 8" | 3 mm |
| 105-17643-4 | 20 cm 8" | 4 mm |
| 105-17643-5 | 20 cm 8" | 5 mm |
| 105-17644-2 | 23 cm 9" | 2 mm |
| 105-17644-3 | 23 cm 9" | 3 mm |
| 105-17644-4 | 23 cm 9" | 4 mm |
| 105-17644-5 | 23 cm 9" | 5 mm |



**Kerrison STILLE laminektomistans |  
Kerrison STILLE Laminectomy Punch**

The same fine Kerrison punches are also available with coating for increased durability.

|               |          |      |
|---------------|----------|------|
| 105-17642-2-C | 18 cm 7" | 2 mm |
| 105-17642-3-C | 18 cm 7" | 3 mm |
| 105-17642-4-C | 18 cm 7" | 4 mm |
| 105-17642-5-C | 18 cm 7" | 5 mm |
| 105-17643-2-C | 20 cm 8" | 2 mm |
| 105-17643-3-C | 20 cm 8" | 3 mm |
| 105-17643-4-C | 20 cm 8" | 4 mm |
| 105-17643-5-C | 20 cm 8" | 5 mm |
| 105-17644-2-C | 23 cm 9" | 2 mm |
| 105-17644-3-C | 23 cm 9" | 3 mm |
| 105-17644-4-C | 23 cm 9" | 4 mm |
| 105-17644-5-C | 23 cm 9" | 5 mm |





### Cushing STILLE bittång | Cushing STILLE Rongeur

Rongeur for intervertebral discs, with semi-detachable shaft.  
Available with or without coating. Jaw size 2x10 mm.

|                |         |          |        |
|----------------|---------|----------|--------|
| 105-13921-18   | 2x10 mm | 18 cm 7" |        |
| 105-13921-18-C | 2x10 mm | 18 cm 7" | Coated |



### Love-Gruenwald STILLE bittång | Love-Gruenwald STILLE Rongeur

Rongeur for intervertebral discs, with semi-detachable shaft.  
Available with or without coating. Jaw size 3x10 mm.

|                |         |          |        |
|----------------|---------|----------|--------|
| 105-13931-18   | 3x10 mm | 18 cm 7" |        |
| 105-13931-18-C | 3x10 mm | 18 cm 7" | Coated |



## Spurling STILLE bittång | Spurling STILLE Rongeur

Rongeur for intervertebral discs, with semi-detachable shaft. Available with or without coating. Jaw size 4x10 mm.

|                |         |          |        |
|----------------|---------|----------|--------|
| 105-13941-18   | 4x10 mm | 18 cm 7" |        |
| 105-13941-18-C | 4x10 mm | 18 cm 7" | Coated |



## Caspar STILLE bittång | Caspar STILLE Rongeur

Rongeur for intervertebral discs, with semi-detachable shaft. Available with or without coating. Fenestrated and serrated jaws in three different sizes.

|                |         |          |        |
|----------------|---------|----------|--------|
| 105-13955-18   | 2x12 mm | 18 cm 7" |        |
| 105-13955-18-C | 2x12 mm | 18 cm 7" | Coated |
| 105-13956-18   | 3x12 mm | 18 cm 7" |        |
| 105-13956-18-C | 3x12 mm | 18 cm 7" | Coated |
| 105-13957-18   | 4x14 mm | 18 cm 7" |        |
| 105-13957-18-C | 4x14 mm | 18 cm 7" | Coated |





**EN KÄRLKLÄMMA MÅSTE GE EXAKT DET TRYCK** som krävs för att stoppa en blödning på ett säkert men ändå atraumatiskt sätt. Stänger klämman inte korrekt om kärlet riskerar det att skadas.

Den approximala stängningen av käftarna mot den distala delen fördelar käftarnas tryck jämnt över blodkärlet. Därmed blir trycket så litet som möjligt, men ändå effektivt. En klämma måste även tåla den mekaniska spänning den utsätts för.

Ett annat säkert kännetecken för STILLEs kärklämmare är det öppna boxlåset, vilket minskar risken för att instrumentet ska fastna i vävnad eller kirurgens handskar. Samtidigt förenklas rengöring och sterilisering. Knäppets unika utformning ser till att kärklämmaren hålls stängd i ett säkert läge samtidigt som den är enkel att öppna igen. Knäppena på STILLEs kärklämmare är försedda med flera steg för att möjliggöra korrekt tryck över kärlet.

I sortimentet ingår också ett antal andra klämmare med samma unika STILLE-kvalitet, som t ex fattningstänger, dukklämmor och ringtänger.

**A VASCULAR CLAMP MUST PROVIDE THE EXACT PRESSURE** required to stop bleeding in a safe and atraumatic way. If the clamp closes improperly the vessel is likely to be damaged.

The closure of the jaws on the distal portion ensures pressure is evenly distributed over the blood vessel. Thus, the pressure is as small as possible while maintaining effectiveness. A clamp must also withstand the mechanical stress it is subjected to.

Another sure characteristic of STILLE's vascular clamps is the open box lock, which reduces the risk of the instrument getting stuck in the tissue or the surgeon's gloves, while simplifying the cleaning and sterilization process. The ratchet's unique design ensures that the instrument stays closed in a safe position while being easy to open. Closures on STILLE vascular clamps are fitted with several steps to allow various degrees of pressure on the vessel.

The range also includes a number of other clamps with the same unique STILLE quality, such as tissue grasping forceps, towel clamps and ring forceps.

# Klämmare | Clamps | Klemmen | Pinze | Pinzas | 血管鉗子および組織把持鉗子

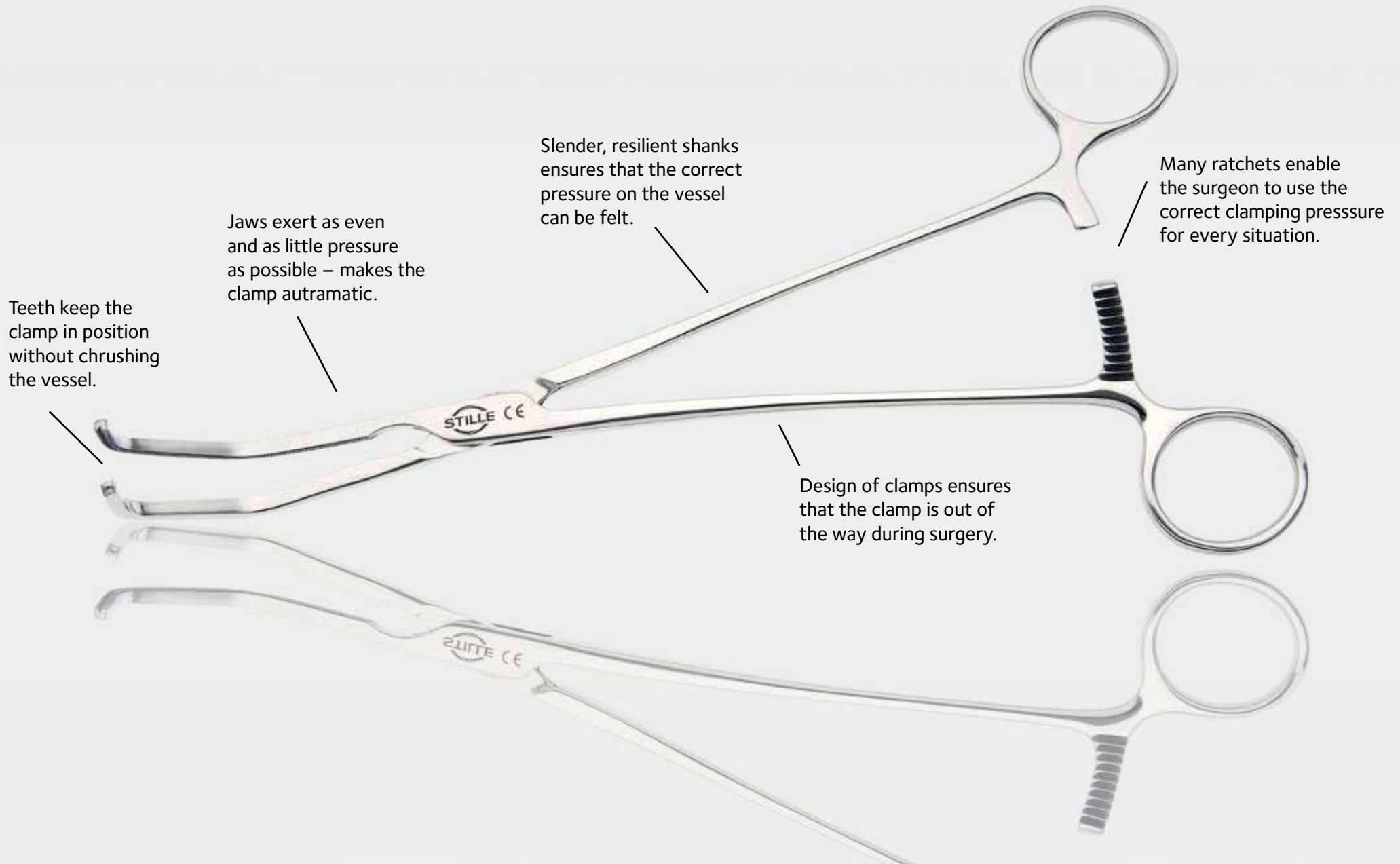

### STILLE colonklämmare | STILLE Colon Clamp

Colon clamp with atraumatic DeBakey jaws. Long ratchet for precise adjustment.

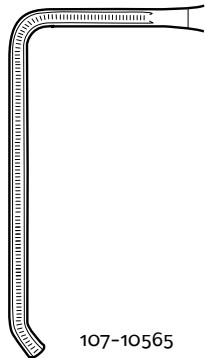

107-10565

107-10565 Atraumatic 5 cm jaws 23.5 cm 9.25"



### Wikström STILLE galltång | Wikström STILLE Gall Duct Clamp

Gall duct clamp with angled, serrated jaws.

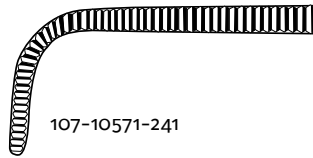

107-10571-241

107-10571-241 Angled 24 cm 9.5"



### Uppsala STILLE galltång | Uppsala STILLE Gall Duct Clamp

Gall duct clamp with S-shaped, serrated jaws.

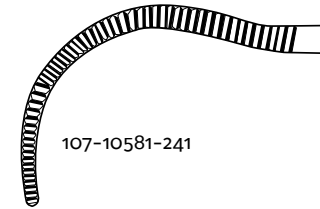

107-10581-241

107-10581-241 S-shaped 24 cm 9.5"



**STILLE mini universalklammare |  
 STILLE mini Multi-purpose clamp**

Multipurpose vascular mini clamps with spoon shaped atraumatic DeBakey jaws.



107-10655



107-10656

|           |               |            |               |
|-----------|---------------|------------|---------------|
| 107-10655 | Small         | 20 mm jaws | 15.5 cm 6.25" |
| 107-10656 | Angled shanks | 20 mm jaws | 15 cm 6"      |



**STILLE mini universalklammare |  
 STILLE mini Multi-purpose clamp**

Multipurpose vascular mini clamps with atraumatic DeBakey jaws.



107-10665



107-10670

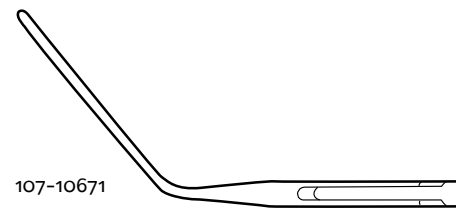

107-10671

|           |                 |            |               |
|-----------|-----------------|------------|---------------|
| 107-10665 | Straight shanks | 25 mm jaws | 15.5 cm 6.25" |
| 107-10670 | Angled 30°      | 30 mm jaws | 15.5 cm 6.25" |
| 107-10671 | Angled 50°      | 30 mm jaws | 15 cm 6"      |





STILLE universalklammare | STILLE  
 Multi-purpose clamp

Multi purpose clamps with angled, atraumatic DeBakey jaws.

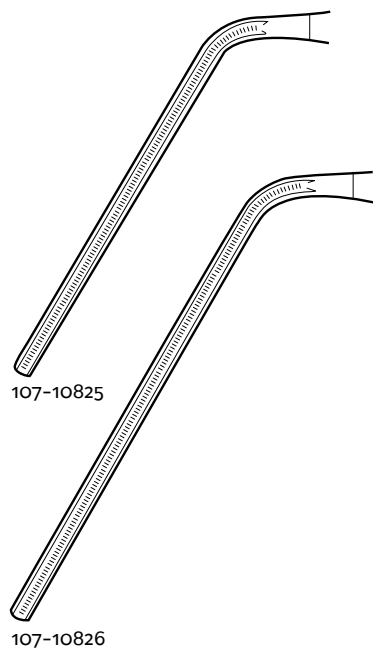

|           |            |             |               |
|-----------|------------|-------------|---------------|
| 107-10825 | Atraumatic | 6 cm jaws   | 23 cm 9"      |
| 107-10826 | Atraumatic | 7.5 cm jaws | 22.5 cm 8.75" |



**STILLE universalklammare | STILLE**  
**Multi-purpose clamp**

Multi purpose clamps with angled, atraumatic DeBakey jaws.

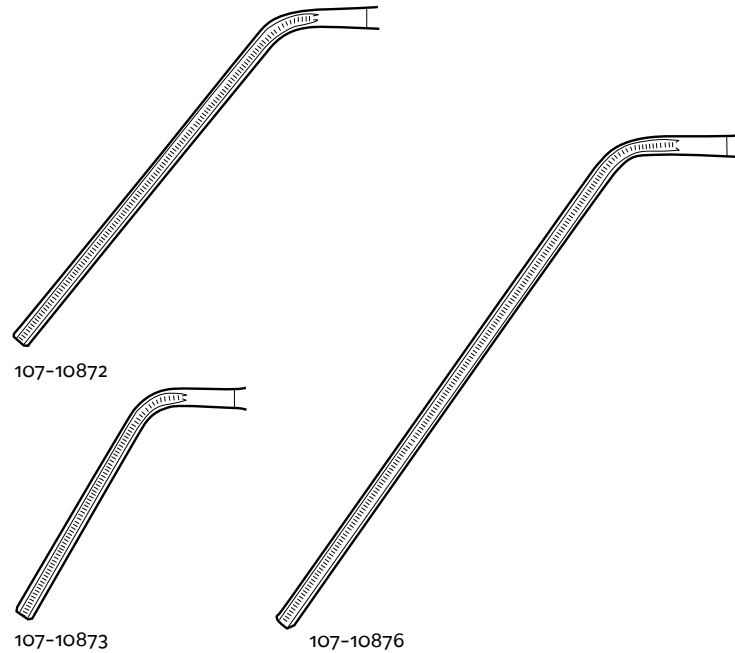

|           |            |             |               |
|-----------|------------|-------------|---------------|
| 107-10872 | Atraumatic | 6 cm jaws   | 18.5 cm 7.25" |
| 107-10873 | Atraumatic | 3.5 cm jaws | 15.5 cm 6.25" |
| 107-10876 | Atraumatic | 8 cm jaws   | 20 cm 8"      |



## STILLE mini tangential occlusionsklämmare | STILLE mini Tangential Occlusion Clamp

Tangential occlusion mini clamps with three different jaw sizes.  
With atraumatic DeBakey jaws.

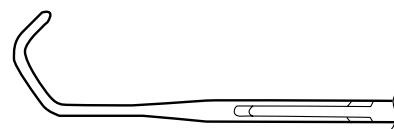

107-10695

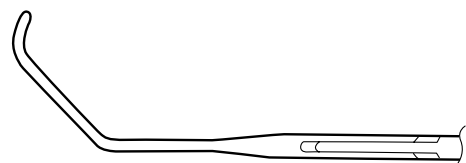

107-10696

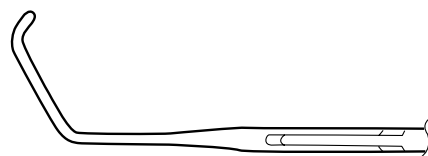

107-10697

|           |        |            |            |
|-----------|--------|------------|------------|
| 107-10695 | Small  | 14 mm jaws | 14 cm 5.5" |
| 107-10696 | Medium | 15 mm jaws | 15 cm 6"   |
| 107-10697 | Large  | 24 mm jaws | 15 cm 6"   |



**Satinsky STILLE tangential occlusionsklämmare**  
 | Satinsky STILLE Tangential Occlusion Clamp

Tangential occlusion clamps with atraumatic DeBakey jaws.

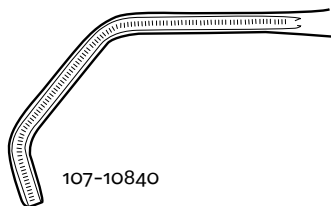

107-10840

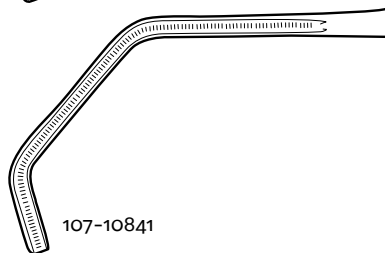

107-10841

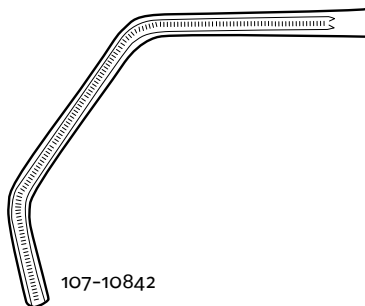

107-10842

|           |            |        |             |
|-----------|------------|--------|-------------|
| 107-10840 | Atraumatic | Small  | 22 cm 8.75" |
| 107-10841 | Atraumatic | Medium | 22.5 cm 9"  |
| 107-10842 | Atraumatic | Large  | 23 cm 9"    |



## STILLE perifer kärlklämmare | STILLE Peripheral Vascular Clamp

Peripheral vascular clamp with atraumatic DeBakey jaws.

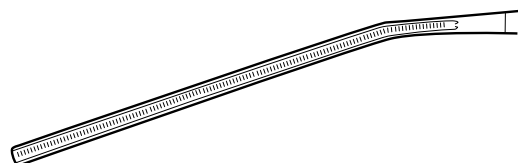

107-10871

107-10871 Atraumatic 6 cm jaws 20 cm 8"

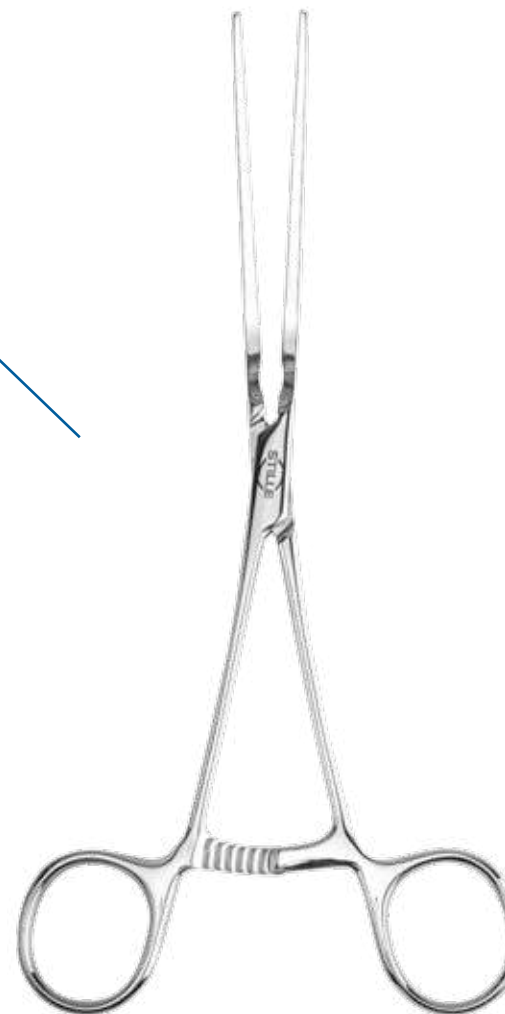

**STILLE anastomosklämmare** | **STILLE Anastomosis Clamp**

Anastomosis clamps with atraumatic DeBakey jaws.

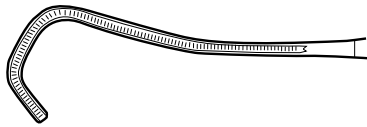

107-10860

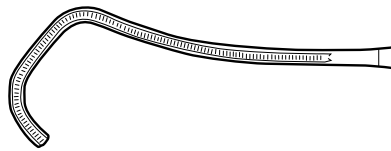

107-10861

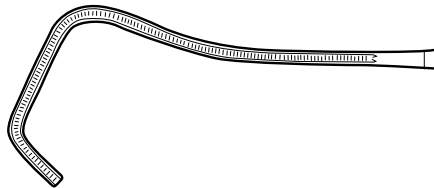

107-10862



|           |            |             |               |
|-----------|------------|-------------|---------------|
| 107-10860 | Atraumatic | 1 cm jaws   | 17,5 cm 7"    |
| 107-10861 | Atraumatic | 1,5 cm jaws | 17,5 cm 7"    |
| 107-10862 | Atraumatic | 2 cm jaws   | 18,5 cm 7.25" |

**Lambert-Kay STILLE aorta anastomosklämmare |**  
**Lambert-Kay STILLE Aortic-Anastomosis Clamp**

Aortic anastomosis clamp with atraumatic DeBakey jaws.

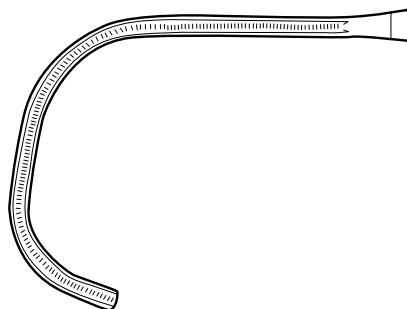

107-10845

107-10845 Atraumatic 22 cm 8.75"



**STILLE DeBakey aorta aneurysmklämmare** |  
**STILLE DeBakey Aortic-Aneurysm Clamp**

Aortic aneurysm clamp with atraumatic DeBakey jaws.

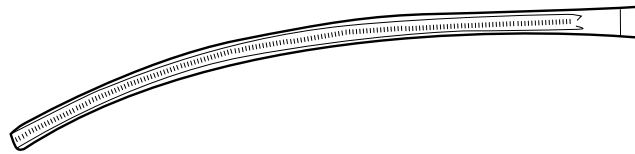

107-10846

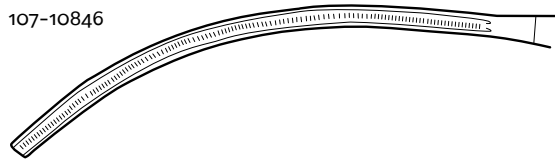

107-10849

|           |            |           |              |
|-----------|------------|-----------|--------------|
| 107-10846 | Atraumatic | 8 cm jaws | 26 cm 10.25" |
| 107-10849 | Atraumatic | 7 cm jaws | 28 cm 11"    |





## Ericsson-STILLE carotisklämmare | Ericsson-STILLE Carotid Clamp

Carotid clamp with angled atraumatic DeBakey jaws.

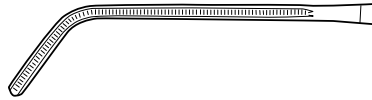

107-10880

107-10880 Atraumatic 17,5 cm 7"



**Ericsson-STILLE profunda arteria femoralis klämmare** | **Ericsson-STILLE Profunda Femoral Artery Clamps**

Profunda femoral artery clamp with atraumatic DeBakey jaws.

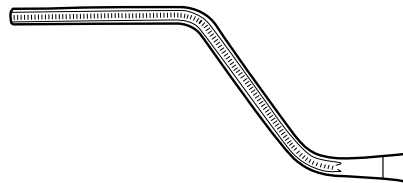

107-10898

107-10898 Atraumatic 18 cm 7"



## Backhaus STILLE dukklämmare | Backhaus STILLE Towel Clamps

Towel clamps in two different versions. Sharp/sharp or ball/socket for paper towels.

|           |             |               |
|-----------|-------------|---------------|
| 107-10910 | Sharp/Sharp | 11 cm 4.25"   |
| 107-10912 | Ball/socket | 13.5 cm 5.25" |



**Babcock STILLE fattningstång | Babcock STILLE  
Intestinal Grasping Forceps**

Intestinal grasping forceps in two different lengths.

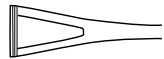

107-12370

|              |             |
|--------------|-------------|
| 107-12370-16 | 16 cm 6.25" |
| 107-12370-20 | 20 cm 8"    |

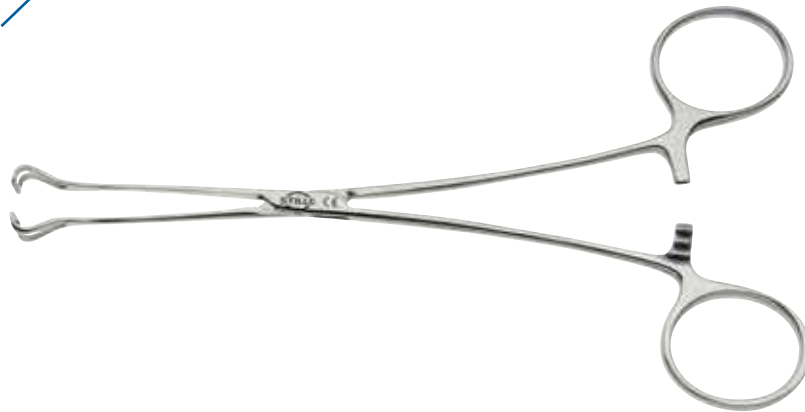

**Duval STILLE fattningstång | Duval STILLE  
Intestinal Grasping Forceps**

Intestinal grasping forceps.

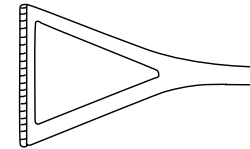

107-12563

|           |          |
|-----------|----------|
| 107-12563 | 18 cm 7" |
|-----------|----------|



## Allis STILLE fattningstång | Allis STILLE Intestinal Grasping Forceps

Tissue-grasping forceps for secure grip of tissue.



107-13120

|              |           |             |
|--------------|-----------|-------------|
| 107-13120-15 | 5X6 teeth | 15 cm 6"    |
| 107-13120-21 | 5X6 teeth | 21 cm 8.25" |



**Allis STILLE fattningstång | Allis STILLE Intestinal Grasping Forceps**

Atraumatic tissue-grasping forceps.

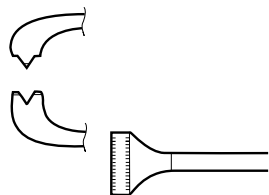

107-13130

- 107-13130-15 Non-traumatic 15.5 cm 6"
- 107-13130-19 Non-traumatic 19 cm 7.5"
- 107-13130-25 Non-traumatic 25 cm 10"

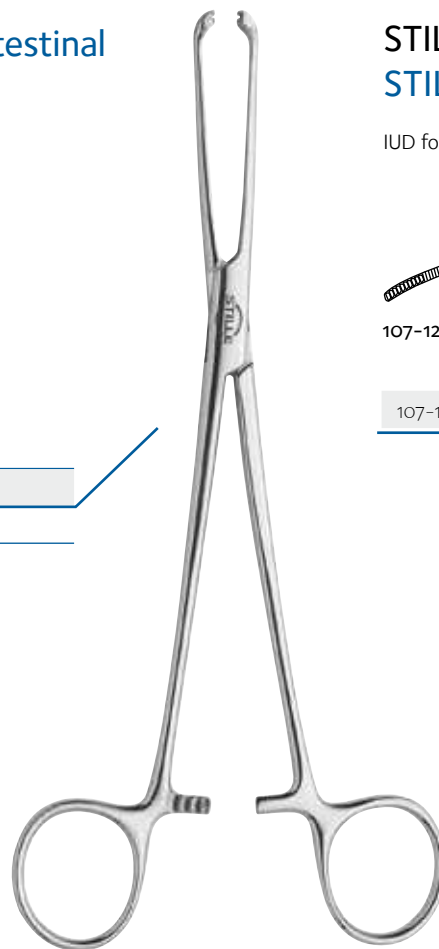

**STILLE-Norell spiraltång | STILLE-Norell IUD Forceps**

IUD forceps with slightly curved, flattened jaws.

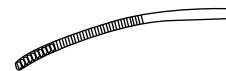

107-12491

- 107-12491 slightly curved 27 cm 10.5"



## Maier STILLE tvättång | Maier STILLE Sponge Holding Forceps

Sponge holding forceps with serrated jaws. Available straight and curved.

|           |              |          |              |
|-----------|--------------|----------|--------------|
| 107-12478 | With ratchet | Straight | 26 cm 10.25" |
| 107-12479 | With ratchet | Curved   | 26 cm 10.25" |

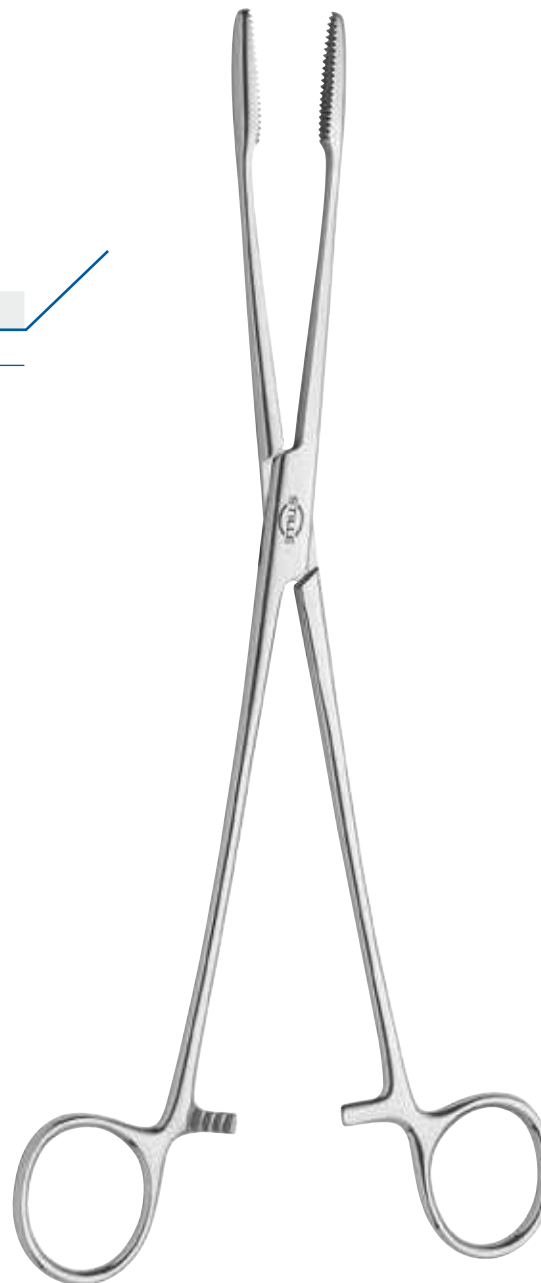

## Foerster STILLE ringtång | Foerster STILLE Sponge Holding Forceps

Sponge holding forceps with several different loops and lengths.

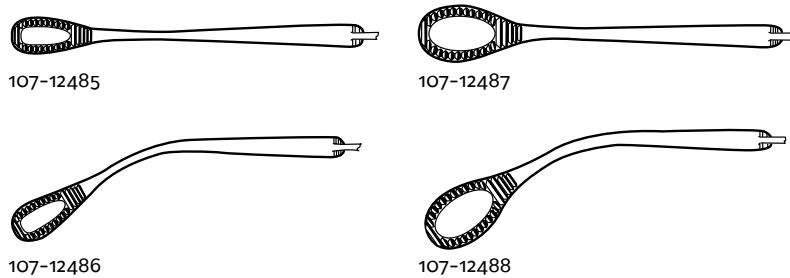

|           |          |                |            |
|-----------|----------|----------------|------------|
| 107-12489 | Serrated | Straight       | 18 cm 7"   |
| 107-12490 | Serrated | Curved         | 18 cm 7"   |
| 107-12485 | Serrated | Straight small | 24 cm 9.5" |
| 107-12486 | Serrated | Curved small   | 24 cm 9.5" |
| 107-12487 | Serrated | Straight large | 24 cm 9.5" |
| 107-12488 | Serrated | Curved large   | 24 cm 9.5" |





## Schroeder STILLE klotång | Schroeder STILLE Tenaculum Forceps

Uterine tenaculum forceps.

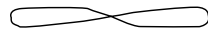

107-13280

107-13280

24 cm 9,5"



## STILLE uterusmanipulator | STILLE Uterine Manipulator

Designed to give better control of the uterus for improved visualization during laparoscopic procedures. Slightly rounded probe with a drop-shaped tip for minimized risk of tissue trauma.

107-13290 Probe 60 mm Curved 26.5 cm 10.5"







**DET ÄR VIKTIGT ATT HAKEN** håller undan vävnaden varligt och atraumatiskt. Därför måste blad, klor och skaft vara så mjukt utformade som möjligt. STILLEs hakar har en design med perfekt rundade kanter och mjuk övergång till klor och blad. Ytan är alltid högglanspolerad för att effektivisera rengöringen och öka livslängden. Handtagen är särskilt utformade för att göra instrumenten bekväma att hantera. Flera modeller har försetts med ergonomiskt utformade handtag.

I sortimentet finns även ett antal självhållande hakar som exempelvis Adsonhakar, Perman bukhakar och revbensspridare.

**IS IMPORTANT THAT A RETRACTOR** holds the tissue gently and without causing trauma. Therefore, the blade, teeth and handle must be designed and shaped as smoothly as possible. STILLE retractors are designed with perfectly rounded edges and smooth transitions to blade and teeth. The instrument surface is always highly polished, which streamlines cleaning and increases longevity. The handles are specifically designed to ensure the instruments are comfortable to use. Several models have been equipped with ergonomically designed handles.

The range also includes a number of self retaining models such as Adson retractors, Perman abdominal retractors and rib spreaders.

# Hakar | Retractors | Wundhaken | Divaricatori | Separadores | 開創器、鉤、レトラクター

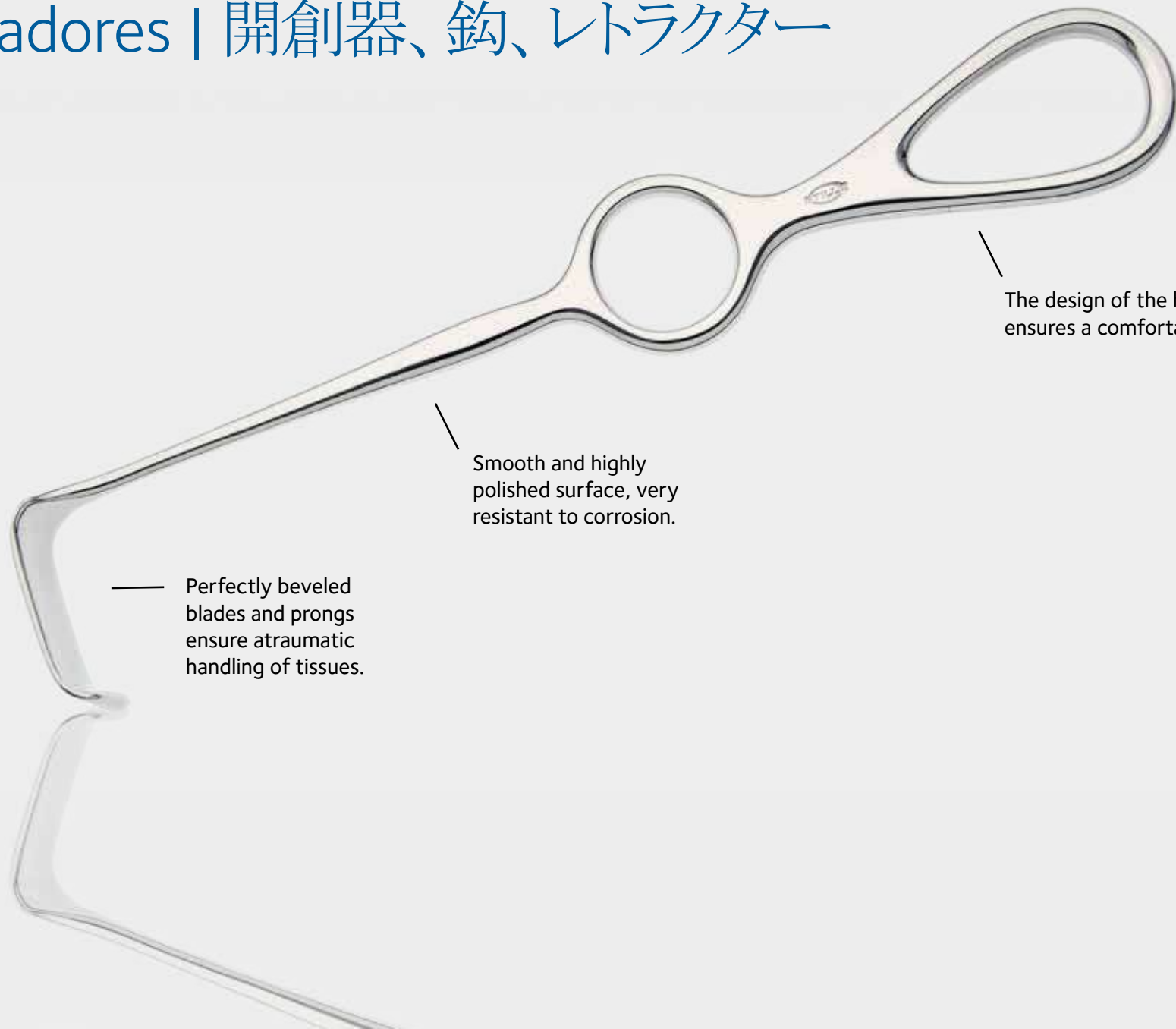

The design of the handle ensures a comfortable grip.

Smooth and highly polished surface, very resistant to corrosion.

Perfectly beveled blades and prongs ensure atraumatic handling of tissues.



### Gillies STILLE hudhake | Gillies STILLE Skin Hook

Skin hook with small or large hook on long flat shaft.



108-24110



108-24112

|           |       |            |
|-----------|-------|------------|
| 108-24110 | Small | 19 cm 7.5" |
| 108-24112 | Large | 19 cm 7.5" |



### Joseph STILLE hudhake | Joseph STILLE Skin Hook

Skin hook with sharp prongs. Available in five different models. Popular in plastic surgery.



108-25011-1



108-25012-2



108-25012-5



108-25012-10

|              |             |       |             |
|--------------|-------------|-------|-------------|
| 108-25011-1  | Single hook |       | 16 cm 6.25" |
| 108-25012-2  | Double hook | 2 mm  | 16 cm 6.25" |
| 108-25012-5  | Double hook | 5 mm  | 16 cm 6.25" |
| 108-25012-7  | Double hook | 7 mm  | 16 cm 6.25" |
| 108-25012-10 | Double hook | 10 mm | 16 cm 6.25" |



### Kleinert-Kutz STILLE hudhake | Kleinert-Kutz STILLE Skin Hook

Skin hook with a sharp single prong in three different sizes. Popular in facial and nasal surgery.



108-25031-3      108-25031-5      108-25031-7

|             |        |      |             |
|-------------|--------|------|-------------|
| 108-25031-3 | Small  | 3 mm | 16 cm 6.25" |
| 108-25031-5 | Medium | 5 mm | 16 cm 6.25" |
| 108-25031-7 | Large  | 7 mm | 16 cm 6.25" |

### STILLE-AI Hussein lambåhake | STILLE-AI Hussein Flap Retractor

Flap retractor with four or five sharp hooks, for secure handling of larger flaps. Developed in cooperation with Ali Al-Husseiny, M.D.

|           |               |       |
|-----------|---------------|-------|
| 108-24116 | 4 sharp hooks | 10 cm |
| 108-24117 | 5 sharp hooks | 15 cm |





### STILLE nervhake | STILLE Nerve Hook

Blunt nerve hook on long flat shaft.



108-24320

108-24320 Slightly curved blunt 22 cm 8.75"



### Love STILLE nervhake | Love STILLE Nerve Hook

Nerve root retractor with long flat shaft.

108-26048-7 7 mm 20.5 cm 8"





### Moberg STILLE hake | Moberg STILLE Retractor

Retractor with flat handle for facial- and hand surgery.

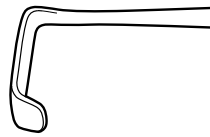

108-24380

|           |         |             |
|-----------|---------|-------------|
| 108-24380 | 14x5 mm | 17 cm 6.75" |
|-----------|---------|-------------|



### Strandell STILLE hake | Strandell STILLE Retractor

Retractor with two different blade lengths. Blades with teeth.

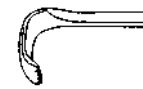

108-24385-8

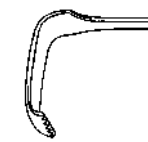

108-24385-15

|              |            |         |            |
|--------------|------------|---------|------------|
| 108-24385-8  | With teeth | 8x5 mm  | 19 cm 7.5" |
| 108-24385-15 | With teeth | 15x5 mm | 19 cm 7.5" |



### STILLE hake | STILLE Retractor

Retractor with one, two or three prongs, sharp or blunt.

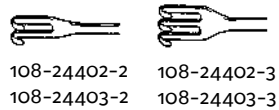
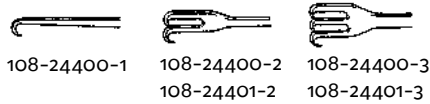

|             |       |          |          |               |
|-------------|-------|----------|----------|---------------|
| 108-24400-1 | Sharp | 1 prong  |          | 18 cm 7"      |
| 108-24400-2 | Sharp | 2 prongs | 6 mm     | 18 cm 7"      |
| 108-24400-3 | Sharp | 3 prongs | 9 mm     | 18 cm 7"      |
| 108-24401-2 | Ergo  | Sharp    | 2 prongs | 6 mm 18 cm 7" |
| 108-24401-3 | Ergo  | Sharp    | 3 prongs | 9 mm 18 cm 7" |
| 108-24402-2 | Blunt | 2 prongs | 6 mm     | 18 cm 7"      |
| 108-24402-3 | Blunt | 3 prongs | 9 mm     | 18 cm 7"      |
| 108-24403-2 | Ergo  | Blunt    | 2 prongs | 6 mm 18 cm 7" |
| 108-24403-3 | Ergo  | Blunt    | 3 prongs | 9 mm 18 cm 7" |



### Volkmann STILLE hake | Volkmann STILLE Retractor

Retractor with one to four prongs. Sharp or blunt.

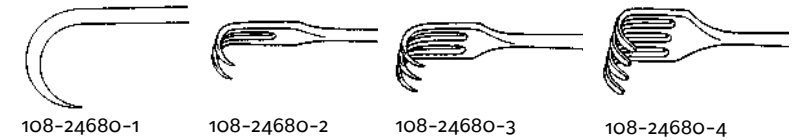

|             |       |          |       |              |
|-------------|-------|----------|-------|--------------|
| 108-24680-1 | Sharp | 1 prong  | Large | 21.5 cm 8.5" |
| 108-24680-2 | Sharp | 2 prongs |       | 22 cm 8.75"  |
| 108-24680-3 | Sharp | 3 prongs |       | 22 cm 8.75"  |
| 108-24680-4 | Sharp | 4 prongs |       | 22 cm 8.75"  |
| 108-24682-2 | Blunt | 2 prongs |       | 22 cm 8.75"  |
| 108-24682-3 | Blunt | 3 prongs |       | 22 cm 8.75"  |
| 108-24682-4 | Blunt | 4 prongs |       | 22 cm 8.75"  |



### Ragnell STILLE hake | Ragnell STILLE Retractor

Double-ended retractor for plastic and reconstructive surgery.

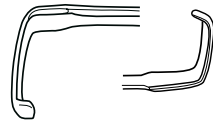

108-24808

|           |              |             |          |
|-----------|--------------|-------------|----------|
| 108-24808 | Double ended | 9x3/15x5 mm | 15 cm 6" |
|-----------|--------------|-------------|----------|



### Langenbeck STILLE hake | Langenbeck STILLE Retractor

General operating retractor with a variety of blade sizes.

|              |          |             |
|--------------|----------|-------------|
| 108-24812-7  | 20x7 mm  | 21 cm 8.25" |
| 108-24814-10 | 30x10 mm | 21 cm 8.25" |
| 108-24814-15 | 30x15 mm | 21 cm 8.25" |
| 108-24814-20 | 30x20 mm | 21 cm 8.25" |
| 108-24816-20 | 45x20 mm | 21 cm 8.25" |



### Senn STILLE hake | Senn STILLE Retractor

Double-ended retractor for plastic surgery.

108-25940 15x5 mm 3 sharp prongs 15 cm 6"

### Aufricht STILLE năshake | Aufricht STILLE Nasal Retractor

Nasal retractor with concave blade.

108-26011 46x10 mm 16 cm 6.25"



### Converse STILLE năshake | Converse STILLE Nasal Retractor

Nasal retractor with concave blade. Curved handle for better grip.



### Deaver STILLE hake | Deaver STILLE Retractor

Flexible standard retractor for breast- and facial surgery.

|              |       |               |
|--------------|-------|---------------|
| 108-26037-19 | 19 mm | 17.5 cm 6.75" |
| 108-26037-22 | 22 mm | 20 cm 8"      |
| 108-26037-25 | 25 mm | 30 cm 12"     |



## STILLE brösthake | STILLE Breast Retractor

Useful double-sided retractor for breast augmentation. Serrated blades in two different sizes and shapes. Ergonomic handle for maximum comfort.

108-26038 Double-ended black coated handle 23 cm 9"



## Desmarres STILLE ögonlockshake | Desmarres STILLE Eye-lid Retractor

For lid retraction in blepharoplasty. Available in four different sizes, with or without insulation.



108-26046-10  
108-26846-10

108-26046-12  
108-26846-12

108-26046-14  
108-26846-14

|              |                 |            |
|--------------|-----------------|------------|
| 108-26046-8  | 8 mm            | 14 cm 5.5" |
| 108-26046-10 | 10 mm           | 14 cm 5.5" |
| 108-26046-12 | 12 mm           | 14 cm 5.5" |
| 108-26046-14 | 14 mm           | 14 cm 5.5" |
| 108-26846-8  | Insulated 8 mm  | 14 cm 5.5" |
| 108-26846-10 | Insulated 10 mm | 14 cm 5.5" |
| 108-26846-12 | Insulated 12 mm | 14 cm 5.5" |
| 108-26846-14 | Insulated 14 mm | 14 cm 5.5" |



## Doyen STILLE bukhahe | Doyen STILLE Abdominal Retractor

The famous STILLE-design abdominal retractor with a variety of blade sizes.  
The handle is rotated 90° for maximum comfort.

|              |           |             |
|--------------|-----------|-------------|
| 108-24930-20 | 90x20mm   | 22 cm 8,75" |
| 108-24930-30 | 90x30mm   | 22 cm 8,75" |
| 108-24935-35 | 110x35mm  | 22 cm 8,75" |
| 108-24935-40 | 110x40mm  | 22 cm 8,75" |
| 108-24935-55 | 110x55mm  | 22 cm 8,75" |
| 108-24940-55 | 120x55 mm | 24 cm 9,5"  |



## Perman STILLE bukhahe | Perman STILLE Abdominal Retractor

Self-retaining abdominal retractor. Can be custom designed in various sizes.

108-26865    Depth 65 mm    Arm length 18 cm 7"





## Kocher STILLE bukspatel | Kocher STILLE Abdominal Spatula

STILLE's classical abdominal spatula, available in three different sizes.  
Also used in orthopaedics.

|              |       |            |
|--------------|-------|------------|
| 108-23780-25 | 25 mm | 22 cm 8,5" |
|--------------|-------|------------|

|              |       |            |
|--------------|-------|------------|
| 108-23780-35 | 35 mm | 22 cm 8,5" |
|--------------|-------|------------|

|              |       |            |
|--------------|-------|------------|
| 108-23780-45 | 45 mm | 22 cm 8,5" |
|--------------|-------|------------|



**Carlens STILLE Tracheotomihake** | Carlens STILLE  
**Trachea Retractor**

Double-ended trachea retractor.

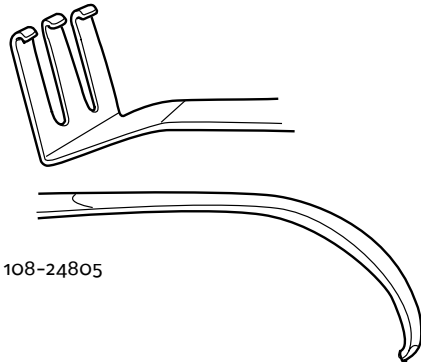

108-24805 Double-ended 22 cm 8.75"



## Weitlaner STILLE hake | Weitlaner STILLE Retractor

General purpose self-retaining retractor used in many procedures.

|           |                  |               |
|-----------|------------------|---------------|
| 108-26252 | 2x3 sharp prongs | 10.5 cm 4.25" |
| 108-26253 | 2x3 blunt prongs | 10.5 cm 4.25" |
| 108-26254 | 3x4 sharp prongs | 13.5 cm 5.25" |
| 108-26255 | 3x4 blunt prongs | 13.5 cm 5.25" |
| 108-26256 | 3x4 sharp prongs | 16.5 cm 6.5"  |
| 108-26257 | 3x4 blunt prongs | 16.5 cm 6.5"  |

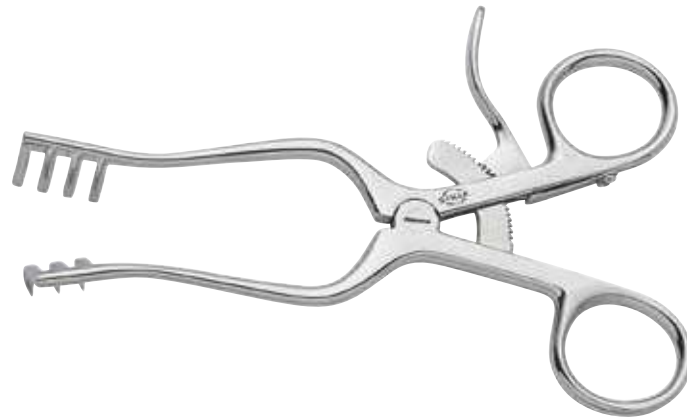

## Alm STILLE hake | Alm STILLE Retractor

Self-retaining retractor for fine incisions. Available in two different sizes.

|           |                  |            |
|-----------|------------------|------------|
| 108-26261 | 4x4 sharp prongs | 7 cm 2.75" |
| 108-26262 | 4x4 sharp prongs | 10 cm 4"   |



Adson STILLE självhållande hake | Adson STILLE  
Self Retaining Retractor

Self retaining retractor with sharp prongs. Available in two different sizes.

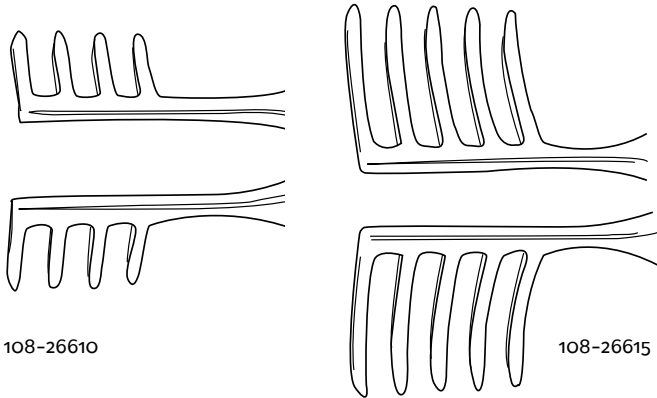

|           |                  |       |             |
|-----------|------------------|-------|-------------|
| 108-26610 | 4x4 sharp prongs | 25 mm | 32 cm 12.5" |
| 108-26615 | 5x5 sharp prongs | 45 mm | 32 cm 12.5" |



## Finochietto STILLE revbensspridare | Finochietto STILLE Rib Spreader

Sternum and rib spreader with interchangeable blades.



108-26931-80

108-26931-100

|               |                |                      |
|---------------|----------------|----------------------|
| 108-26931     | Self-retaining | with blades 50x50 mm |
| 108-26931-80  | Blades         | 1 pair 80x50 mm      |
| 108-26931-100 | Blades         | 1 pair 30x100 mm     |



### Vienna STILLE nässpekulum | Vienna STILLE Nasal Speculum

Nasal speculas in three different sizes.

|             |       |            |
|-------------|-------|------------|
| 108-27011-1 | 24 mm | 14 cm 5.5" |
| 108-27011-2 | 30 mm | 14 cm 5.5" |
| 108-27011-3 | 34 mm | 14 cm 5.5" |



### Cottle STILLE nässpekulum | Cottle STILLE Nasal Speculum

Nasal speculum with locking screw.

|             |       |            |
|-------------|-------|------------|
| 108-27021-2 | 55 mm | 14 cm 5.5" |
|-------------|-------|------------|







**SKRAPNING, FRILÄGGNING ELLER BORTTAGNING** av mjuk och hård vävnad samt andra precisa arbeten kräver ett lätt handlag. Instrumenten måste vara starka men samtidigt följsamma för att undvika skador.

STILLE erbjuder ett sortiment av kyretter, raspatorier, dissektorer och elevatorier av allra högsta kvalitet. Materialet är högglanspolerat rostfritt stål med just de egenskaper som är så viktiga för denna typ av produkter. Stålet är tillräckligt hårt för att hantera hård benvävnad och hålla sig vasst samtidigt som det måste vara följsamt för att inte skada implantat.

I den här produktgruppen ingår också STILLES välkända uteruskyretter. De tillverkas numera med skaft av ohärdat rostfritt stål vilket ger dem de precisa böjbara egenskaperna som behövs. Instrumentet behöver inte beläggas med ett yttskikt av nickel vilket förlänger hållbarheten och ökar patientsäkerheten.

**SCRAPING, UNCOVERING OR REMOVAL** of soft and hard tissue and other precision work requires a light touch. The instruments must be strong, yet flexible enough to avoid damage.

STILLE offers an assortment of curettes, raspatories, dissectors and elevators of the very highest quality. The material is highly polished stainless steel with precisely the qualities that are so important for these types of instruments. The steel is hard enough to deal with hard bone tissue and to remain sharp, yet flexible enough to avoid damaging implants.

This instrument group also includes STILLE's well known uterine curettes. They are designed with shafts of unhardened stainless steel, which gives them the precise flexibility required. The instruments need not be coated with a surface layer of nickel, which prolongs durability and increases patient safety.





Slevar, Raspatorier, Elevatorier etc. | Currettes,  
Raspatories, Elevators etc. | Löffel, Raspatorien,  
Elevatorien etc. | Curette, Staccaperiostio,  
Elevatori etc. | Cucharillas, Legras, Elevadores etc. |  
鋭匙、やすり骨膜起子

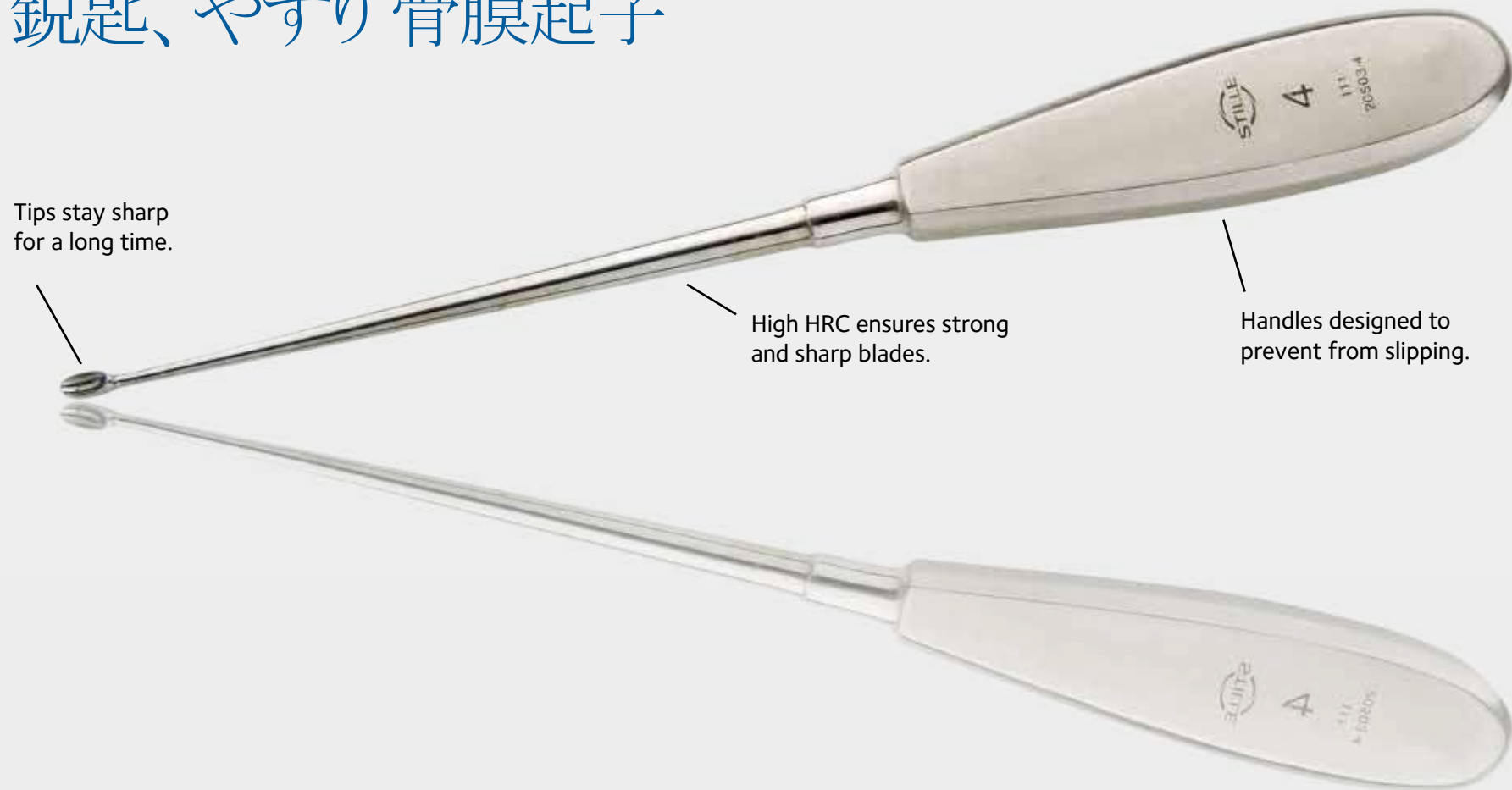

Tips stay sharp  
for a long time.

High HRC ensures strong  
and sharp blades.

Handles designed to  
prevent from slipping.

## Récamier STILLE uteruskyrett | Récamier STILLE Uterine curette

Malleable uterine curettes in different sizes. With shaft in non-hardened stainless steel, ensures long-time function without any surface coating falling off. Higher patient safety and longer life-time expectancy.

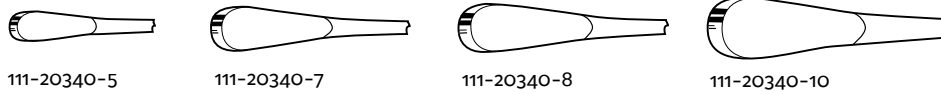

111-20340-5

111-20340-7

111-20340-8

111-20340-10



111-20350-7

111-20350-8

111-20350-10

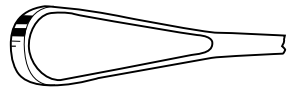

111-20350-12

|              |       |       |           |
|--------------|-------|-------|-----------|
| 111-20340-5  | Sharp | 5 mm  | 30 cm 12" |
| 111-20340-7  | Sharp | 7 mm  | 30 cm 12" |
| 111-20340-8  | Sharp | 8 mm  | 30 cm 12" |
| 111-20340-10 | Sharp | 10 mm | 30 cm 12" |
| 111-20350-7  | Blunt | 7 mm  | 30 cm 12" |
| 111-20350-8  | Blunt | 8 mm  | 30 cm 12" |
| 111-20350-10 | Blunt | 10 mm | 30 cm 12" |
| 111-20350-12 | Blunt | 12 mm | 30 cm 12" |





### STILLE slev | STILLE Bone curette

Oval and sharp bone curettes with widths from 2 mm to 12 mm.

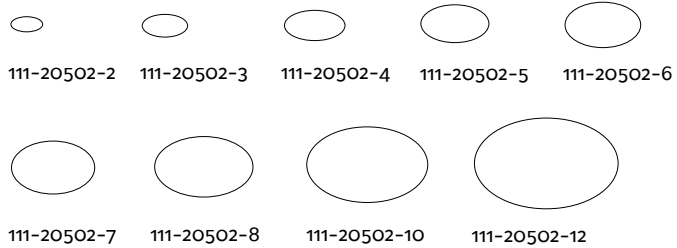

|              |            |       |               |
|--------------|------------|-------|---------------|
| 111-20502-2  | Sharp oval | 2 mm  | 17.5 cm 7"    |
| 111-20502-3  | Sharp oval | 3 mm  | 18 cm 7"      |
| 111-20502-4  | Sharp oval | 4 mm  | 18.5 cm 7.25" |
| 111-20502-5  | Sharp oval | 5 mm  | 18.5 cm 7.25" |
| 111-20502-6  | Sharp oval | 6 mm  | 18.5 cm 7.25" |
| 111-20502-7  | Sharp oval | 7 mm  | 19 cm 7.5"    |
| 111-20502-8  | Sharp oval | 8 mm  | 19.5 cm 7.75" |
| 111-20502-10 | Sharp oval | 10 mm | 21 cm 8.25"   |
| 111-20502-12 | Sharp oval | 12 mm | 21 cm 8.25"   |



### STILLE slev | STILLE Bone curette

Oval and sharp bone curettes with widths from 2 mm to 6 mm. Longer Shaft version.

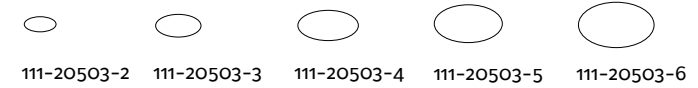

|             |            |      |          |
|-------------|------------|------|----------|
| 111-20503-2 | Sharp oval | 2 mm | 23 cm 9" |
| 111-20503-3 | Sharp oval | 3 mm | 23 cm 9" |
| 111-20503-4 | Sharp oval | 4 mm | 23 cm 9" |
| 111-20503-5 | Sharp oval | 5 mm | 23 cm 9" |
| 111-20503-6 | Sharp oval | 6 mm | 23 cm 9" |



### Olivecrona STILLE raspatorium | Olivecrona STILLE Raspatory

Raspatory with sturdy and ergonomic handle. Curved tip.

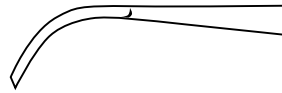

111-22150

|           |        |       |             |
|-----------|--------|-------|-------------|
| 111-22150 | Curved | 11 mm | 17 cm 6.75" |
|-----------|--------|-------|-------------|

### Cobb STILLE raspatorium | Cobb STILLE Raspatory

Popular raspatory with round handle. Available with several different tip sizes.

|              |       |                |
|--------------|-------|----------------|
| 111-22155-10 | 10 mm | 28,5 cm 11.25" |
| 111-22155-13 | 13 mm | 28,5 cm 11.25" |
| 111-22155-19 | 19 mm | 28,5 cm 11.25" |
| 111-22155-25 | 25 mm | 28,5 cm 11.25" |





### Cottle STILLE raspatorium | Cottle STILLE Raspatory

Commonly used raspatory with a sharp 9 mm rounded tip.

|             |      |            |
|-------------|------|------------|
| 111-22158-9 | 9 mm | 19 cm 7.5" |
|-------------|------|------------|



### Lambotte STILLE raspatorium | Lambotte STILLE Raspatory

Raspatory with a wide 23 mm tip.



111-22160

|           |        |       |             |
|-----------|--------|-------|-------------|
| 111-22160 | Curved | 23 mm | 21 cm 8.25" |
|-----------|--------|-------|-------------|



### Wiberg STILLE raspatorium | Wiberg STILLE Raspatory

A straight raspatory in four different sizes.

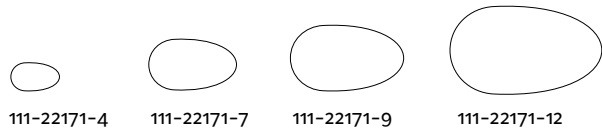

111-22171-4

111-22171-7

111-22171-9

111-22171-12

|              |          |      |             |
|--------------|----------|------|-------------|
| 111-22171-4  | Straight | 4 mm | 17 cm 6.75" |
| 111-22171-7  | Straight | 7 mm | 17 cm 6.75" |
| 111-22171-9  | Straight | 9 mm | 17 cm 6.75" |
| 111-22171-12 | Straight | 12mm | 17 cm 6.75" |



### Ragnell STILLE raspatorium | Ragnell STILLE Raspatory

Double-ended raspatory with blunt hooks.

111-22350 Blunt hook 17 cm 6.75"



### Howarth STILLE näsraspatorium | Howarth STILLE Nasal Raspatory

Double-ended nasal raspatory with sharp hooks.

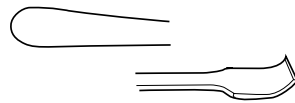

111-22370

111-22370 Double-ended 22 cm 8.75"



### Joseph STILLE raspatorium | Joseph STILLE Raspatory

Slightly curved raspatory with flat handle.

111-22385-4 4 mm 17 cm 6.75"

## STILLE näsraspatorium | STILLE Nasal Raspatory

Sharp, slightly curved nasal raspatory.

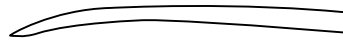

111-22520-4

111-22520-4 Slightly curved Sharp 4 mm 18 cm 7"







### Freer STILLE elevatorium | Freer STILLE Elevator

Double-ended elevator sharp/blunt with rounded, delicate handle.

|             |        |               |
|-------------|--------|---------------|
| 111-22140-4 | 4.5 mm | 19.5 cm 7.75" |
| 111-22140-6 | 6.5 mm | 19.5 cm 7.75" |



### STILLE näselevatorium | STILLE Nasal Elevator

Blunt nasal elevator.



111-22522-4

|             |                       |      |          |
|-------------|-----------------------|------|----------|
| 111-22522-4 | Slightly curved blunt | 4 mm | 18 cm 7" |
|-------------|-----------------------|------|----------|



Cottle STILLE septum elevator | Cottle  
STILLE Septum Elevator

Double-ended fine elevator with graduated shafts.

|           |           |            |          |
|-----------|-----------|------------|----------|
| 111-22532 | Graduated | 3.3/3.7 mm | 23 cm 9" |
|-----------|-----------|------------|----------|



Langenbeck STILLE elevator | Langenbeck  
STILLE Elevator

Sturdy elevator mainly used in orthopaedics. Available in two sizes.

|              |       |               |
|--------------|-------|---------------|
| 111-22550-8  | 8 mm  | 19.5 cm 7.75" |
| 111-22550-10 | 10 mm | 19.5 cm 7.75" |



### Mini-Hohmann STILLE elevatorium | Mini-Hohmann STILLE Elevator

Finer version of the Hohmann elevator. Used in foot surgery.

|             |            |      |             |
|-------------|------------|------|-------------|
| 111-22565-6 | Bone lever | 6 mm | 16 cm 6.25" |
| 111-22565-8 | Bone lever | 8 mm | 16 cm 6.25" |



### Hohmann STILLE elevatorium | Hohmann STILLE Elevator

General utility bone lever for orthopaedic surgery.

|              |         |       |              |
|--------------|---------|-------|--------------|
| 111-22567-9  | Rounded | 9 mm  | 22 cm 8.75"  |
| 111-22568-18 | Rounded | 18 mm | 24 cm 9.5"   |
| 111-22569-18 | Flat    | 18 mm | 25.5 cm 10"  |
| 111-22569-24 | Flat    | 24 mm | 26 cm 10.25" |



### STILLE elevatorium | STILLE Elevator

Standard bone lever in two different sizes.

|             |      |               |
|-------------|------|---------------|
| 111-22563-3 | 3 mm | 14.5 cm 5.75" |
| 111-22563-6 | 6 mm | 14.5 cm 5.75" |



### Stolte STILLE tonsillelevatorium | Stolte STILLE Tonsil Elevator

Curved double-ended tonsil elevator.

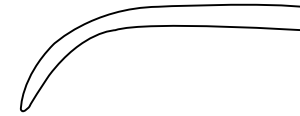

111-22635

|           |              |          |
|-----------|--------------|----------|
| 111-22635 | Double-ended | 20 cm 8" |
|-----------|--------------|----------|

## STILLE dissektor | STILLE Dissector

Double-ended dissector in several different models.

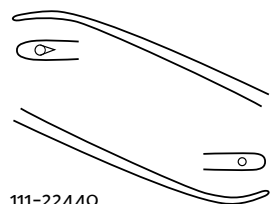

111-22440

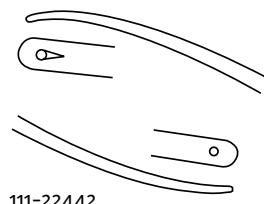

111-22442

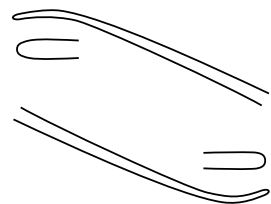

111-22440

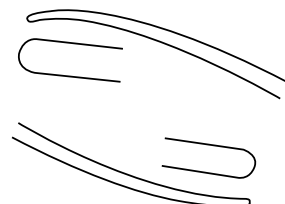

111-22442

|              |                     |               |
|--------------|---------------------|---------------|
| 111-22440-18 | Fine with hole      | 18 cm 7"      |
| 111-22440-24 | Fine with hole      | 24 cm 9.5"    |
| 111-22442-19 | Coarse with hole    | 19.5 cm 7.75" |
| 111-22442-24 | Coarse with hole    | 24 cm 9.5"    |
| 111-22444    | Fine without hole   | 24.5 cm 9.75" |
| 111-22446    | Coarse without hole | 24.5 cm 9.5"  |



## Fomon STILLE rasp | Fomon STILLE Rasp

Double-ended rasp with TC-inserts for better durability. Low profile for better access in narrow areas.

|           |                |              |
|-----------|----------------|--------------|
| 111-22860 | TC-inserts 1&2 | 21,5 cm 8,5" |
| 111-22861 | TC-inserts 3&4 | 21,5 cm 8,5" |
| 111-22862 | TC-inserts 5&6 | 21,5 cm 8,5" |
| 111-22863 | TC-inserts 7&8 | 21,5 cm 8,5" |







**OSTEOTOMER, MEJSLAR, GOUGEMEJSLAR** och andra beninstrument från STILLE tillverkas i ett härdat kvalitetsstål med särskilt hög hårdhet för att undvika brytskador eller böjningar. Hårdheten ökar tåligheten mot slitage och stålets seghet avgör hur väl det står emot stora påfrestningar under lång tid.

Det är valet av material med precis rätt hårdhet (HRC-värde) i kombination med tillverkningsmetod som ger instrumentet dess unika skäregenskaper. Eggen är lagd i en perfekt vinkel för maximal skärprestanda. Spetsen är hård nog för att den inte ska fastna i benet. Samtidigt är den mjuk nog för att ge med sig i kontakt med implantat.

Specialslipningen gör att instrumenten förblir vassa under en längre tid innan de behöver slipas om. Handtagen är ergonomiskt utformade för ett handfast grepp. STILLE var först i världen med att tillverka osteotomer och instrumenten har genom åren blivit kända för sina unika egenskaper. Den klassiska STILLE-osteotomen är idag ett begrepp över hela världen.

**OSTEOTOMES, CHISELS, MALLETS** and other bone instruments from STILLE are made of high quality hardened steel, with particularly high strength to avoid breakage or bending. The hardness increases resistance to wear and the toughness of the steel determines how well the instrument can withstand great strain for long periods of time.

The choice of material with just the right hardness value (HRC) in combination with the manufacturing method provides the instrument with its unique cutting properties. The edges are placed at the perfect angle for maximum cutting performance. The tip is stiff enough so that it will not get caught in the bone, and soft enough to give way when in contact with implants.

Special sharpening techniques allow the instruments to remain sharp for extended periods before they need to be resharpened. The handles are ergonomically designed for a firm and comfortable grip. STILLE was the first in the world to manufacture osteotomes and over the years the instruments have become known for their unique properties. The classic STILLE osteotome is known the world over.





Osteotomer, mejslar etc. | Osteotomes, Chisels etc. |  
Osteotome, Flachmeissel etc. | Osteotomi, Scalpelli etc. |  
Escoplos, Cinceles etc. | 両刃のみ 片刃のみ



High HRC ensures that the instruments stay sharp.

Handle designed to ensure perfect grip and ergonomomy.

Highest quality steel and hardening for maximum life expectancy.

Special tip grinding for maximum cutting performance.

### STILLE osteotom | STILLE Osteotome

The famous STILLE original osteotome, available in 5 different sizes.

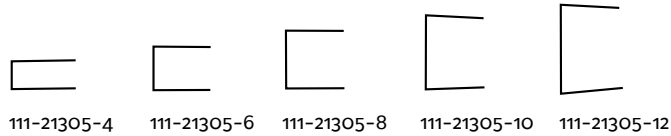

|              |       |             |
|--------------|-------|-------------|
| 111-21305-4  | 4 mm  | 21 cm 8.25" |
| 111-21305-6  | 6 mm  | 21 cm 8.25" |
| 111-21305-8  | 8 mm  | 21 cm 8.25" |
| 111-21305-10 | 10 mm | 21 cm 8.25" |
| 111-21305-12 | 12 mm | 21 cm 8.25" |



### STILLE osteotom | STILLE Osteotome

Delicate osteotome with cross-serrated head. Available in 5 different sizes.

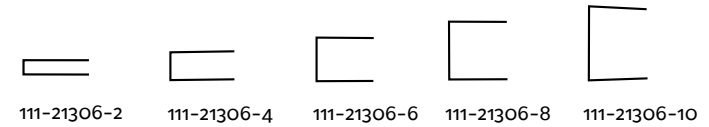

|              |       |              |
|--------------|-------|--------------|
| 111-21306-2  | 2 mm  | 16.5 cm 6.6" |
| 111-21306-4  | 4 mm  | 16.5 cm 6.5" |
| 111-21306-6  | 6 mm  | 16.5 cm 6.5" |
| 111-21306-8  | 8 mm  | 16.5 cm 6.5" |
| 111-21306-10 | 10 mm | 16.5 cm 6.5" |





### STILLE osteotom | STILLE Osteotome

Osteotome in 5 different sizes. Slightly thicker blade than the STILLE-Kaye osteotome.

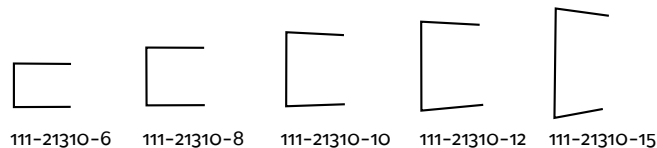

111-21310-6    111-21310-8    111-21310-10    111-21310-12    111-21310-15

|              |       |              |
|--------------|-------|--------------|
| 111-21310-6  | 6 mm  | 16,5 cm 6,5" |
| 111-21310-8  | 8 mm  | 16,5 cm 6,5" |
| 111-21310-10 | 10 mm | 16,5 cm 6,5" |
| 111-21310-12 | 12 mm | 16,5 cm 6,5" |
| 111-21310-15 | 15 mm | 16,5 cm 6,5" |



### STILLE osteotom | STILLE Osteotome

Osteotome available in 6 different sizes.

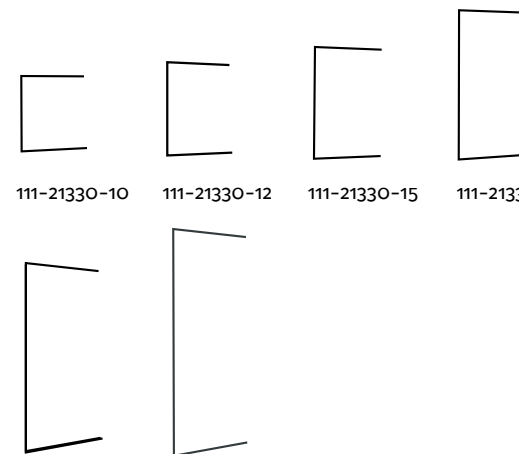

111-21330-10    111-21330-12    111-21330-15    111-21330-20

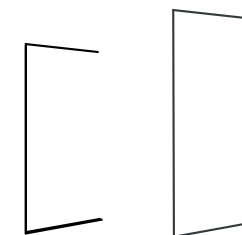

111-21330-25    111-21330-30

|              |       |             |
|--------------|-------|-------------|
| 111-21330-10 | 10 mm | 21 cm 8,25" |
| 111-21330-12 | 12 mm | 21 cm 8,25" |
| 111-21330-15 | 15 mm | 21 cm 8,25" |
| 111-21330-20 | 20 mm | 21 cm 8,25" |
| 111-21330-25 | 25 mm | 21 cm 8,25" |
| 111-21330-30 | 30 mm | 21 cm 8,25" |



### Lambotte STILLE osteotom | Lambotte STILLE Osteotome

Straight osteotome available in 6 different sizes.

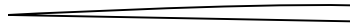

111-21441

|              |          |       |          |
|--------------|----------|-------|----------|
| 111-21441-7  | Straight | 7 mm  | 23 cm 9" |
| 111-21441-15 | Straight | 15 mm | 23 cm 9" |
| 111-21441-20 | Straight | 20 mm | 23 cm 9" |
| 111-21441-25 | Straight | 25 mm | 23 cm 9" |
| 111-21441-30 | Straight | 30 mm | 23 cm 9" |
| 111-21441-40 | Straight | 40 mm | 23 cm 9" |



### Lambotte STILLE osteotom | Lambotte STILLE Osteotome

Curved version of the Lambotte osteotome available in 4 different sizes.

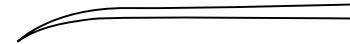

111-21442

|              |        |       |          |
|--------------|--------|-------|----------|
| 111-21442-7  | Curved | 7 mm  | 23 cm 9" |
| 111-21442-15 | Curved | 15 mm | 23 cm 9" |
| 111-21442-20 | Curved | 20 mm | 23 cm 9" |
| 111-21442-25 | Curved | 25 mm | 23 cm 9" |



## Lambotte STILLE miniosteotom | Lambotte STILLE Mini Osteotome

Delicate mini osteotome in 11 different sizes.

### 111-21450

|              |          |       |            |
|--------------|----------|-------|------------|
| 111-21450-2  | Straight | 2 mm  | 12.5 cm 5" |
| 111-21450-3  | Straight | 3 mm  | 12.5 cm 5" |
| 111-21450-4  | Straight | 4 mm  | 12.5 cm 5" |
| 111-21450-5  | Straight | 5 mm  | 12.5 cm 5" |
| 111-21450-6  | Straight | 6 mm  | 12.5 cm 5" |
| 111-21450-7  | Straight | 7 mm  | 12.5 cm 5" |
| 111-21450-8  | Straight | 8 mm  | 12.5 cm 5" |
| 111-21450-9  | Straight | 9 mm  | 12.5 cm 5" |
| 111-21450-10 | Straight | 10 mm | 12.5 cm 5" |
| 111-21450-11 | Straight | 11 mm | 12.5 cm 5" |
| 111-21450-12 | Straight | 12 mm | 12.5 cm 5" |



### STILLE handosteotom | STILLE Hand Osteotome

Delicate osteotome with phenolic handle. Intended for hand surgery, but also useful in other fine orthopaedic work.

|              |       |            |
|--------------|-------|------------|
| 111-21456-2  | 2 mm  | 16cm 6.25" |
| 111-21456-4  | 4 mm  | 16cm 6.25" |
| 111-21456-6  | 6 mm  | 16cm 6.25" |
| 111-21456-8  | 8 mm  | 16cm 6.25" |
| 111-21456-10 | 10 mm | 16cm 6.25" |
| 111-21456-12 | 12 mm | 16cm 6.25" |



### Lexer STILLE osteotom | Lexer STILLE Osteotome

Osteotome with phenolic handle.

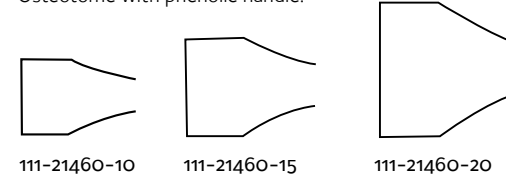

111-21460-10

111-21460-15

111-21460-20

|              |       |             |
|--------------|-------|-------------|
| 111-21460-10 | 10 mm | 21 cm 8.25" |
| 111-21460-15 | 15 mm | 21 cm 8.25" |
| 111-21460-20 | 20 mm | 21 cm 8.25" |



### Neivert STILLE osteotom | Neivert STILLE Osteotome

Delicate single-guarded osteotome for lateral osteotomy in rhinoplasty.

|             |              |          |
|-------------|--------------|----------|
| 111-21501-1 | Curved left  | 20 cm 8" |
| 111-21501-2 | Curved right | 20 cm 8" |
| 111-21501-3 | Straight     | 20 cm 8" |



### Cinelli STILLE osteotom | Cinelli STILLE Osteotome

Double-guarded osteotome for hump removal.

|              |       |             |
|--------------|-------|-------------|
| 111-21517-10 | 10 mm | 16 cm 6.25" |
| 111-21517-12 | 12 mm | 16 cm 6.25" |
| 111-21517-14 | 14 mm | 16 cm 6.25" |

## Cottle STILLE osteotom | Cottle STILLE Osteotome

Graduated fine osteotome in five different sizes.

|              |       |          |
|--------------|-------|----------|
| 111-21477-4  | 4 mm  | 18 cm 7" |
| 111-21477-6  | 6 mm  | 18 cm 7" |
| 111-21477-8  | 8 mm  | 18 cm 7" |
| 111-21477-10 | 10 mm | 18 cm 7" |
| 111-21477-12 | 12 mm | 18 cm 7" |





## STILLE mejsel | STILLE Chisel

Original STILLE-design chisel in five different sizes from 6 mm to 15 mm.

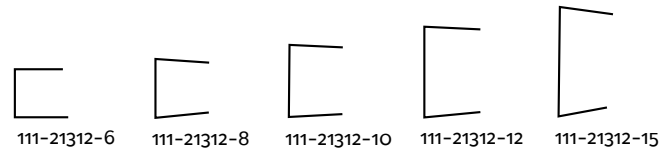

|              |       |              |
|--------------|-------|--------------|
| 111-21312-6  | 6 mm  | 16.5 cm 6,5" |
| 111-21312-8  | 8 mm  | 16.5 cm 6,5" |
| 111-21312-10 | 10 mm | 16.5 cm 6,5" |
| 111-21312-12 | 12 mm | 16.5 cm 6,5" |
| 111-21312-15 | 15 mm | 16.5 cm 6,5" |



### STILLE gougemejsel | STILLE Gouge

Original STILLE gouge. Available in five different sizes from 6 mm to 15 mm.

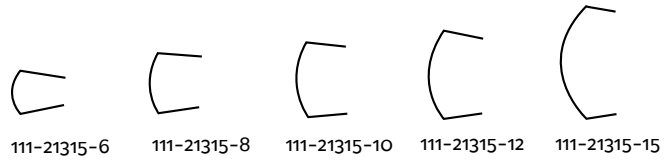

|              |       |              |
|--------------|-------|--------------|
| 111-21315-6  | 6 mm  | 16.5 cm 6.5" |
| 111-21315-8  | 8 mm  | 16.5 cm 6.5" |
| 111-21315-10 | 10 mm | 16.5 cm 6.5" |
| 111-21315-12 | 12 mm | 16.5 cm 6.5" |
| 111-21315-15 | 15 mm | 16.5 cm 6.5" |



### STILLE gougemejsel | STILLE Gouge

Original STILLE gouge. Available in four different sizes from 10 mm to 20 mm.

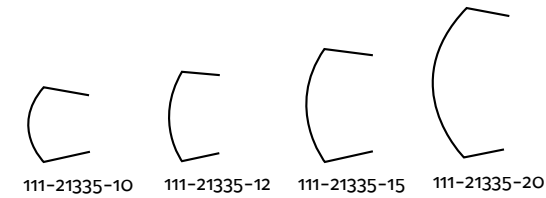

|              |       |             |
|--------------|-------|-------------|
| 111-21335-10 | 10 mm | 21 cm 8.25" |
| 111-21335-12 | 12 mm | 21 cm 8.25" |
| 111-21335-15 | 15 mm | 21 cm 8.25" |
| 111-21335-20 | 20 mm | 21 cm 8.25" |



## STILLE pryl | STILLE Awl

Awl with phenolic handle.



## STILLE hammare | STILLE Mallet

Stainless steel mallet.

111-21820    200 g 7 oz    21.5 cm 8.5"





### STILLE hammare | STILLE Mallet

Mallet with stainless steel head, phenolic handle and interchangeable teflon insert.

|             |                     |             |             |
|-------------|---------------------|-------------|-------------|
| 111-21825   | Mallet              | 145 g, 7 oz | 17 cm 6.75" |
| 111-21825-5 | Spare Teflon insert |             |             |

### STILLE hammare | STILLE Mallet

Mallet with interchangeable plastic head and stainless steel handle.

|             |                    |               |            |
|-------------|--------------------|---------------|------------|
| 111-21920   | Mallet             | 245 g, 8.5 oz | 24 cm 9.5" |
| 111-21920-5 | Spare Plastic head |               |            |





**DE MEST KOMPLICERADE OPERATIONERNA** inom mikrokirurgi kräver högsta precision ända in i minsta detalj. STILLES mikroinstrument är handgjorda av skickliga instrumentmakare och erbjuder perfekt precision och balans.

Sortimentet är i första hand inriktat mot plastikkirurgi och hjärta/-kärlkirurgi. Saxar, pincetter och nålförare finns i flera olika längder och utföranden för att passa alla kirurgers unika önskemål. De svarta eller blåa handtagen indikerar att instrumentet är ett äkta STILLE-instrument.

**THE MOST COMPLEX MICROSURGICAL PROCEDURES** require precision down to the finest detail. STILLE micro instruments are hand-made by skilled craftsman and provide perfect precision and balance.

The instrument range is primarily focused on plastic surgery and cardio/-vascular surgical procedures. Scissors, forceps and needle holders are available in various lengths and designs to suit any surgeon's unique requirements. The black or blue handles indicate that the instrument is an authentic STILLE design.

# Mikroinstrument | Micro instruments | Mikro-instrumente | Strumenti per microchirurgia | Instrumentos para microcirugia | マイクロ器具

The satin finished surface guarantees freedom from glare. The surgeon's eyes do not become tired even during long operations.

Anatomically adapted to the surgeon's hand.

Grooved handle in order to reduce the weight of the instrument.

All edges, the spring unit, pivot and the grip are designed so that gloves cannot be damaged.

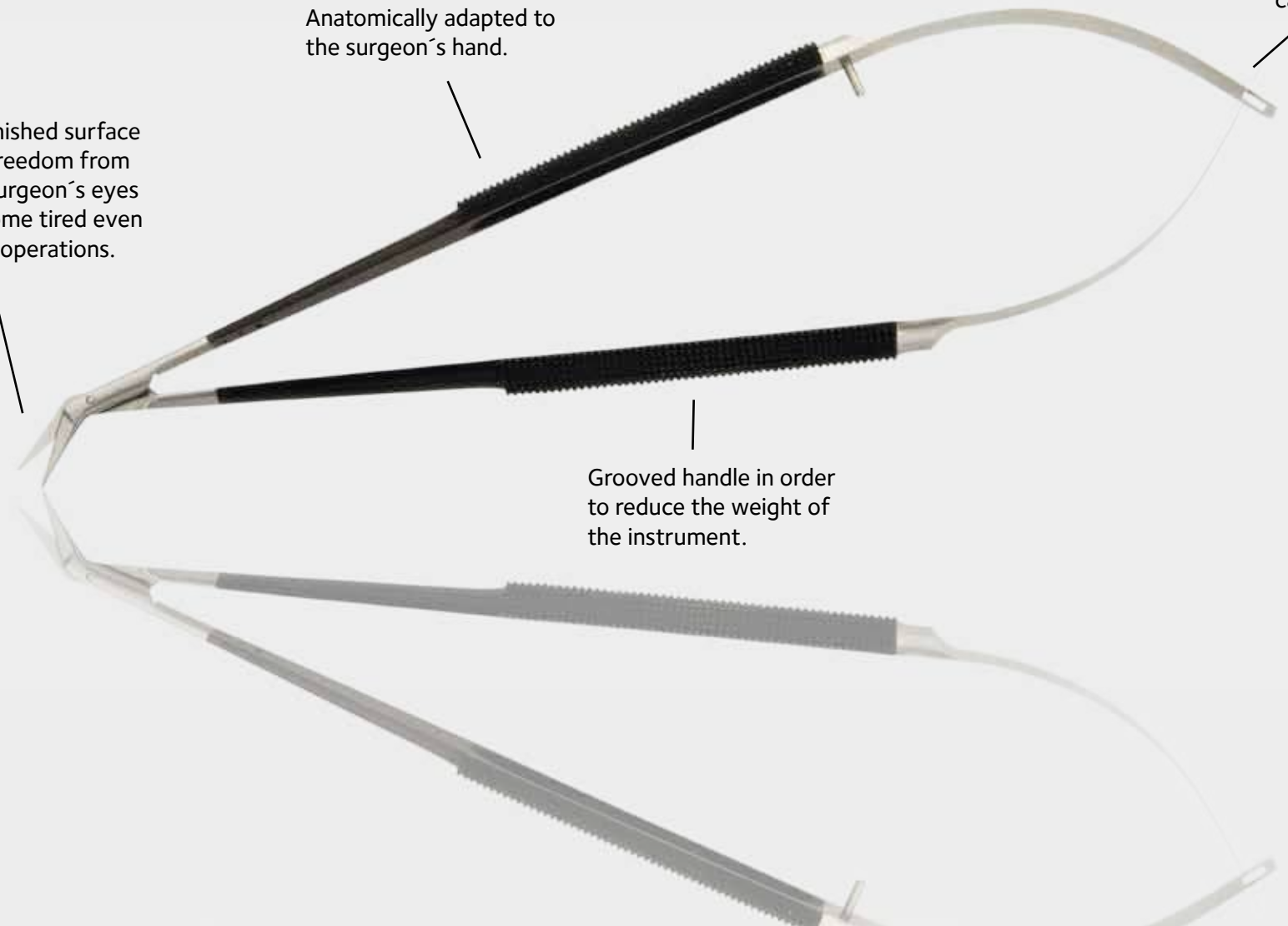



STILLE mikrosax | STILLE Micro Scissors

### MIKROSAXAR

Sortimentet består av både raka och böjda modeller i olika längder, bladstorlek och vinklar. Alla modeller är gjorda med STILLE original SuperCut blad för perfekt precision och prestanda i mjuk vävnad. Ledskraven kan tas bort och återmonteras i samband med service. Efter service skall instrumentet fungera med precis samma känsla och pålitlighet som ett nytt instrument.

### MICRO SCISSORS

The STILLE Micro scissors consist of both straight and curved models in different lengths, blade sizes and angles. All models are made with the original STILLE Supercut blades for consistent cutting performance in soft tissue. Our joint screw design allows for easy removal during instrument service and repair. After service, the instrument will perform with the same feel and reliability you come to expect from a STILLE instrument.



STILLE mikropincett | STILLE Micro Forceps

### MIKROPINCETTER

Alla STILLE mikropincetter är gjorda för att ge samma känsla och balans som våra standard-pincetter. Våra duktiga instrumentmakare är fokuserade på de detaljer som ger perfekt fjäderspänning och matchning av spetsarna för att mjukt och enkelt kunna greppa vävnad och suturer. Pincetterna erbjuds i rostfritt stål eller titan, modeller finns med suturplattform, 1x2 klor, ringspetsar och DeBakey atraumatiska kärpincetter. Käftarna kan fås som standard i rostfritt, eller med Diamond Jaws för utökad hållbarhet och greppstyrka.



STILLE Titan mikropincett | STILLE Titanium Micro Forceps

### MICRO FORCEPS

All STILLE Micro Forceps are designed to give the same feel and balance as our standard line of forceps. Our attention to detail by our skilled artisans in Sweden, combines both perfect spring tension and tip alignment for reliable grasping of tissue. They are available in Titanium or stainless steel that include tying platform, 1x2 teeth, ring tips and DeBakey. The tips are available in stainless steel or STILLE Diamond jaws for added durability.





STILLE mikronålförare | STILLE Micro Needle Holder

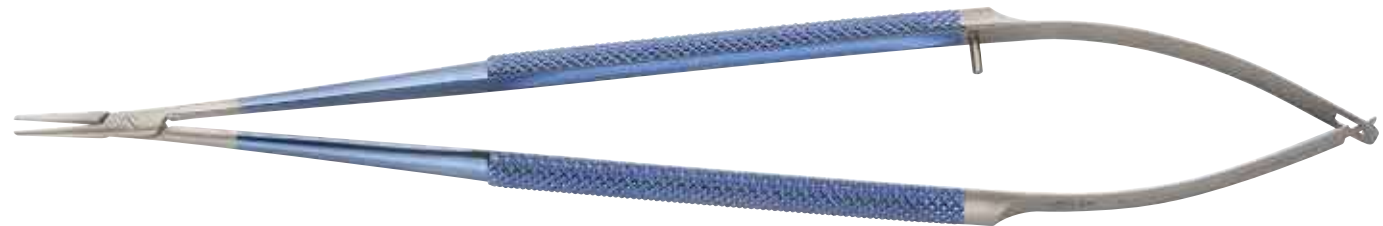

STILLE Titan mikronålförare | STILLE Titanium Micro Needle Holder

### MIKRONÅLFÖRARE

STILLES mikronålförare är designade för att hålla även de finaste mikrosuturerna. Bara ett minimalt tryck behövs från kirurgens fingrar för ett säkert grepp. Alla modeller är försedda med STILLE Diamond Jaws eller på de kraftigare modellerna hårdmetallplattor. De erbjuds som raka eller böjda, med- eller utan låsning och i ett flertal olika längder. Leddesign Regular för 7-0 suturer och finare eller Streamline för 5-0 och finare (kraftiga modellerna för 2-0 till 4-0).

### MICRO NEEDLE HOLDERS

The STILLE Micro Needle Holders are designed to hold the finest sutures in a tight and secure grip. Only minimal pressure will need to be applied by surgeon's fingers. All models are made with STILLE Diamond Jaws and the heavier models with TC-inserts. They can be delivered as straight or curved, with or without ratchet and in several different lengths. Regular box lock for 7-0 sutures and finer, Streamline box lock for 5-0 sutures and finer. (heavy models for 2-0 to 4-0).



## STILLE SuperCut mikrosax | STILLE SuperCut Micro Scissors

Fine micro scissors with straight or curved blades with sharp or blunt tips. All models with **SuperCut** blades.



117-A110  
117-A112



117-A111  
117-A113

|             |            |          |               |
|-------------|------------|----------|---------------|
| 117-A110-15 | Sharp tips | Straight | 15 cm 6"      |
| 117-A110-18 | Sharp tips | Straight | 18 cm 7"      |
| 117-A110-21 | Sharp tips | Straight | 21 cm 8.25"   |
| 117-A112-15 | Blunt tips | Straight | 15 cm 6 in    |
| 117-A112-18 | Blunt tips | Straight | 18 cm 7 in    |
| 117-A112-21 | Blunt tips | Straight | 21 cm 8.25 in |
| 117-A111-15 | Blunt tips | Curved   | 15 cm 6"      |
| 117-A111-18 | Blunt tips | Curved   | 18 cm 7"      |
| 117-A111-21 | Blunt tips | Curved   | 21 cm 8.25"   |
| 117-A113-15 | Sharp tips | Curved   | 15 cm 6 in    |
| 117-A113-18 | Sharp tips | Curved   | 18 cm 7 in    |
| 117-A113-21 | Sharp tips | Curved   | 21 cm 8.25 in |



## STILLE SuperCut mikrokärlsax | STILLE SuperCut Micro Vascular Scissors

**SuperCut** micro scissors available in five different blade angles for fine vascular surgery. Blade length 11 mm.

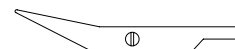

117-A120-25  
117-A121-25

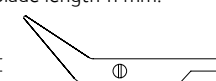

117-A120-45  
117-A121-45

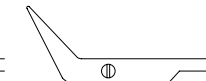

117-A120-60  
117-A121-60

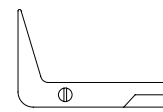

117-A120-90  
117-A121-90

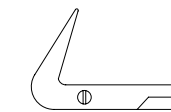

117-A120-125  
117-A121-125

|              |             |               |
|--------------|-------------|---------------|
| 117-A120-25  | Angled 25°  | 18 cm 7"      |
| 117-A120-45  | Angled 45°  | 18 cm 7"      |
| 117-A120-60  | Angled 60°  | 18 cm 7"      |
| 117-A120-90  | Angled 90°  | 18 cm 7"      |
| 117-A120-125 | Angled 125° | 18 cm 7"      |
| 117-A121-25  | Angled 25°  | 21 cm 8.25 in |
| 117-A121-45  | Angled 45°  | 21 cm 8.25 in |
| 117-A121-60  | Angled 60°  | 21 cm 8.25 in |
| 117-A121-90  | Angled 90°  | 21 cm 8.25 in |
| 117-A121-125 | Angled 125° | 21 cm 8.25 in |

## STILLE SuperCut mikrokärlsax | STILLE SuperCut Micro Vascular Scissors

Extra fine blade version of STILLE **SuperCut** vascular micro scissors.  
Blade length 7.5 mm.

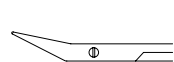

117-A125-25

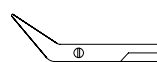

117-A125-45

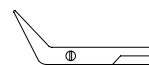

117-A125-60

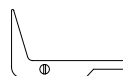

117-A125-90



117-A125-125

|              |             |          |
|--------------|-------------|----------|
| 117-A125-25  | Angled 25°  | 18 cm 7" |
| 117-A125-45  | Angled 45°  | 18 cm 7" |
| 117-A125-60  | Angled 60°  | 18 cm 7" |
| 117-A125-90  | Angled 90°  | 18 cm 7" |
| 117-A125-125 | Angled 125° | 18 cm 7" |





### STILLE mikropincett | STILLE Micro Forceps

Well balanced and ergonomic micro forceps of ultra high quality. With tying platform and straight or curved jaws. 0.4 mm tips.

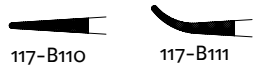

|             |          |             |
|-------------|----------|-------------|
| 117-B110-15 | Straight | 15 cm 6"    |
| 117-B110-18 | Straight | 18 cm 7"    |
| 117-B110-21 | Straight | 21 cm 8.25" |
| 117-B110-23 | Straight | 23 cm 9 in  |
| 117-B111-15 | Curved   | 15 cm 6"    |
| 117-B111-18 | Curved   | 18 cm 7"    |
| 117-B111-21 | Curved   | 21 cm 8.25" |



### STILLE mikropincett | STILLE Micro Forceps

Same fine micro forceps, with Diamond Jaws, for increased tip durability and secure grip of fine needles. 0.4 mm tips.

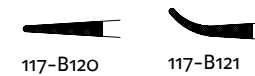

|             |              |          |             |
|-------------|--------------|----------|-------------|
| 117-B120-15 | Diamond Jaws | Straight | 15 cm 6"    |
| 117-B120-18 | Diamond Jaws | Straight | 18 cm 7"    |
| 117-B120-21 | Diamond Jaws | Straight | 21 cm 8.25" |
| 117-B120-23 | Diamond Jaws | Straight | 23 cm 9 in  |
| 117-B121-15 | Diamond Jaws | Curved   | 15 cm 6"    |
| 117-B121-18 | Diamond Jaws | Curved   | 18 cm 7"    |
| 117-B121-21 | Diamond Jaws | Curved   | 21 cm 8.25" |



### STILLE mikropincett | STILLE Micro Forceps

Micro forceps with Diamond Jaws and Counter-balance. 0.4 mm tips.

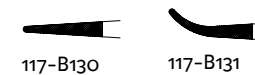

|             |              |          |             |
|-------------|--------------|----------|-------------|
| 117-B130-18 | Diamond Jaws | Straight | 18 cm 7"    |
| 117-B130-21 | Diamond Jaws | Straight | 21 cm 8.25" |
| 117-B130-23 | Diamond Jaws | Straight | 23 cm 9 in  |
| 117-B131-18 | Diamond Jaws | Curved   | 18 cm 7"    |
| 117-B131-21 | Diamond Jaws | Curved   | 21 cm 8.25" |

### STILLE mikro ringpincett | STILLE Micro Ring Forceps

Counter-balanced micro forceps with fine Diamond Jaws ring tips.



117-B140

|             |            |              |          |             |
|-------------|------------|--------------|----------|-------------|
| 117-B140-18 | 1.0x0.5 mm | Diamond Jaws | Straight | 18 cm 7"    |
| 117-B140-21 | 1.0x0.5 mm | Diamond Jaws | Straight | 21 cm 8.25" |
| 117-B140-23 | 1.0x0.5 mm | Diamond Jaws | Straight | 23 cm 9 in  |



### STILLE mikro klopincett | STILLE Micro Tissue Forceps

Round handle, with 1x2 fine teeth on 0.4 mm tips.

|             |                |          |             |
|-------------|----------------|----------|-------------|
| 117-B150-15 | 1x2 fine teeth | Straight | 15 cm 6"    |
| 117-B150-18 | 1x2 fine teeth | Straight | 18 cm 7"    |
| 117-B150-21 | 1x2 fine teeth | Straight | 21 cm 8.25" |



### STILLE DeBaKey mikropincett | STILLE Micro DeBaKey Forceps

Round handle, with 1.2 mm fine atraumatic DeBaKey tips.

|             |        |              |          |               |
|-------------|--------|--------------|----------|---------------|
| 117-B160-18 | 1.2 mm | DeBaKey tips | Straight | 18 cm 7 in    |
| 117-B160-21 | 1.2 mm | DeBaKey tips | Straight | 21 cm 8.25 in |



### STILLE DeBaKey mikropincett | STILLE Micro DeBaKey Forceps

Round handle, with 1.2 mm fine atraumatic DeBaKey tips, counter-balanced.

|             |        |              |          |               |
|-------------|--------|--------------|----------|---------------|
| 117-B165-18 | 1.2 mm | DeBaKey tips | Straight | 18 cm 7 in    |
| 117-B165-21 | 1.2 mm | DeBaKey tips | Straight | 21 cm 8.25 in |



**STILLE Titan mikropincett**  
| **STILLE Titanium Micro Forceps**

Round handle, with tying platform, straight or curved 0.4 mm tips.

|                |              |          |               |
|----------------|--------------|----------|---------------|
| 117-B120-18-TI | Diamond Jaws | Straight | 18 cm 7 in    |
| 117-B120-21-TI | Diamond Jaws | Straight | 21 cm 8.25 in |
| 117-B120-23-TI | Diamond Jaws | Straight | 23 cm 9 in    |
| 117-B120-25-TI | Diamond Jaws | Straight | 25 cm 10 in   |
| 117-B121-18-TI | Diamond Jaws | Curved   | 18 cm 7 in    |
| 117-B121-21-TI | Diamond Jaws | Curved   | 21 cm 8.25 in |
| 117-B121-23-TI | Diamond Jaws | Curved   | 23 cm 9 in    |
| 117-B121-25-TI | Diamond Jaws | Curved   | 25 cm 10 in   |



**STILLE Titan mikropincett**  
| **STILLE Titanium Micro Forceps**

Round handle, with tying platform, counter-balanced, straight or curved 0.4 mm tips.

|                |              |          |               |
|----------------|--------------|----------|---------------|
| 117-B130-18-TI | Diamond Jaws | Straight | 18 cm 7 in    |
| 117-B130-21-TI | Diamond Jaws | Straight | 21 cm 8.25 in |
| 117-B131-18-TI | Diamond Jaws | Curved   | 18 cm 7 in    |
| 117-B131-21-TI | Diamond Jaws | Curved   | 21 cm 8.25 in |





### STILLE Titan mikro ringpincett | STILLE Titanium Micro Ring Forceps

Round handle, with fine ring tips, counter-balanced.

|                |              |                      |          |               |
|----------------|--------------|----------------------|----------|---------------|
| 117-B140-18-TI | Diamond Jaws | 1.0x0.5 mm ring tips | Straight | 18 cm 7 in    |
| 117-B140-21-TI | Diamond Jaws | 1.0x0.5 mm ring tips | Straight | 21 cm 8.25 in |
| 117-B140-23-TI | Diamond Jaws | 1.0x0.5 mm ring tips | Straight | 23 cm 9 in    |



### STILLE Titan DeBakey mikropincett | STILLE Titanium Micro DeBakey Forceps

Round handle, with 1.2 mm fine atraumatic DeBakey tips.

|                |                     |          |               |
|----------------|---------------------|----------|---------------|
| 117-B160-18-TI | 1.2 mm DeBakey tips | Straight | 18 cm 7 in    |
| 117-B160-21-TI | 1.2 mm DeBakey tips | Straight | 21 cm 8.25 in |





### STILLE mikro nålförare | STILLE Micro Needle Holder

Round handle, fine 0.8 mm Diamond Jaws and **Regular Box Lock** for sutures 7-0 and smaller. Without ratchet.



|             |              |          |             |
|-------------|--------------|----------|-------------|
| 117-C110-15 | Diamond Jaws | Straight | 15 cm 6"    |
| 117-C110-18 | Diamond Jaws | Straight | 18 cm 7"    |
| 117-C110-21 | Diamond Jaws | Straight | 21 cm 8.25" |
| 117-C110-23 | Diamond Jaws | Straight | 23 cm 9"    |
| 117-C111-15 | Diamond Jaws | Curved   | 15 cm 6"    |
| 117-C111-18 | Diamond Jaws | Curved   | 18 cm 7"    |
| 117-C111-21 | Diamond Jaws | Curved   | 21 cm 8.25" |
| 117-C111-23 | Diamond Jaws | Curved   | 23 cm 9"    |

### STILLE mikro nålförare | STILLE Micro Needle Holder

Round handle, 1.2 mm Diamond Jaws and **Streamline Box Lock** for sutures 5-0 and smaller. Without ratchet.

|             |              |                 |          |               |
|-------------|--------------|-----------------|----------|---------------|
| 117-C115-15 | Diamond Jaws | Without Ratchet | Straight | 15 cm 6 in    |
| 117-C115-18 | Diamond Jaws | Without Ratchet | Straight | 18 cm 7 in    |
| 117-C115-21 | Diamond Jaws | Without Ratchet | Straight | 21 cm 8.25 in |
| 117-C115-23 | Diamond Jaws | Without Ratchet | Straight | 23 cm 9 in    |
| 117-C116-15 | Diamond Jaws | Without Ratchet | Curved   | 15 cm 6 in    |
| 117-C116-18 | Diamond Jaws | Without Ratchet | Curved   | 18 cm 7 in    |
| 117-C116-21 | Diamond Jaws | Without Ratchet | Curved   | 21 cm 8.25 in |
| 117-C116-23 | Diamond Jaws | Without Ratchet | Curved   | 23 cm 9 in    |



### STILLE mikro nålförare | STILLE Micro Needle Holder

Round handle, fine 0.8 mm Diamond Jaws and **Regular Box Lock** for sutures 7-0 and smaller. With ratchet.



|             |              |          |             |
|-------------|--------------|----------|-------------|
| 117-C120-15 | Diamond Jaws | Straight | 15 cm 6"    |
| 117-C120-18 | Diamond Jaws | Straight | 18 cm 7"    |
| 117-C120-21 | Diamond Jaws | Straight | 21 cm 8.25" |
| 117-C120-23 | Diamond Jaws | Straight | 23 cm 9"    |
| 117-C121-15 | Diamond Jaws | Curved   | 15 cm 6"    |
| 117-C121-18 | Diamond Jaws | Curved   | 18 cm 7"    |
| 117-C121-21 | Diamond Jaws | Curved   | 21 cm 8.25" |
| 117-C121-23 | Diamond Jaws | Curved   | 23 cm 9"    |





## STILLE mikro nålförare | STILLE Micro Needle Holder

Round handle, 1,2 mm Diamond Jaws and **Streamline Box Lock** for sutures 5-0 and smaller. With ratchet.

|             |              |              |          |               |
|-------------|--------------|--------------|----------|---------------|
| 117-C125-15 | Diamond Jaws | With Ratchet | Straight | 15 cm 6 in    |
| 117-C125-18 | Diamond Jaws | With Ratchet | Straight | 18 cm 7 in    |
| 117-C125-21 | Diamond Jaws | With Ratchet | Straight | 21 cm 8.25 in |
| 117-C125-23 | Diamond Jaws | With Ratchet | Straight | 23 cm 9 in    |
| 117-C126-15 | Diamond Jaws | With Ratchet | Curved   | 15 cm 6 in    |
| 117-C126-18 | Diamond Jaws | With Ratchet | Curved   | 18 cm 7 in    |
| 117-C126-21 | Diamond Jaws | With Ratchet | Curved   | 21 cm 8.25 in |
| 117-C126-23 | Diamond Jaws | With Ratchet | Curved   | 23 cm 9 in    |



## STILLE mikro nålförare | STILLE Micro Needle Holder

Extra heavy model for handling of larger needles with TC-inserts. Intended for 2/0 suture and finer.



117-C130  
117-C140

|             |            |              |             |
|-------------|------------|--------------|-------------|
| 117-C130-19 | TC-inserts | Without lock | 19 cm 7.5"  |
| 117-C130-23 | TC-inserts | Without lock | 23 cm 9"    |
| 117-C130-25 | TC-inserts | Without lock | 25 cm 9.75" |
| 117-C140-19 | TC-inserts | With lock    | 19 cm 7.5"  |
| 117-C140-23 | TC-inserts | With lock    | 23 cm 9"    |
| 117-C140-25 | TC-inserts | With lock    | 25 cm 9.75" |



## STILLE Titan mikronålförare | STILLE Titanium Micro Needle Holder

Round handle, fine 0.8 mm Diamond Jaws and **Regular Box Lock** for sutures 7-0 and smaller. With or without ratchet.

|                |              |                 |          |               |
|----------------|--------------|-----------------|----------|---------------|
| 117-C110-18-TI | Diamond Jaws | Without Ratchet | Straight | 18 cm 7 in    |
| 117-C110-21-TI | Diamond Jaws | Without Ratchet | Straight | 21 cm 8.25 in |
| 117-C110-23-TI | Diamond Jaws | Without Ratchet | Straight | 23 cm 9 in    |
| 117-C111-15-TI | Diamond Jaws | Without Ratchet | Curved   | 15 cm 6 in    |
| 117-C111-18-TI | Diamond Jaws | Without Ratchet | Curved   | 18 cm 7 in    |
| 117-C111-21-TI | Diamond Jaws | Without Ratchet | Curved   | 21 cm 8.25 in |
| 117-C120-18-TI | Diamond Jaws | With Ratchet    | Straight | 18 cm 7 in    |
| 117-C120-21-TI | Diamond Jaws | With Ratchet    | Straight | 21 cm 8.25 in |
| 117-C120-23-TI | Diamond Jaws | With Ratchet    | Straight | 23 cm 9 in    |
| 117-C121-18-TI | Diamond Jaws | With Ratchet    | Curved   | 18 cm 7 in    |
| 117-C121-21-TI | Diamond Jaws | With Ratchet    | Curved   | 21 cm 8.25 in |
| 117-C121-23-TI | Diamond Jaws | With Ratchet    | Curved   | 23 cm 9 in    |





## STILLE Titan mikronålförare | STILLE Titanium Micro Needle Holder

Round handle, 1.2 mm Diamond Jaws and **Streamline Box Lock** for sutures 5-0 and smaller. With or without ratchet.

|                |              |                 |          |               |
|----------------|--------------|-----------------|----------|---------------|
| 117-C115-18-TI | Diamond Jaws | Without Ratchet | Straight | 18 cm 7 in    |
| 117-C115-21-TI | Diamond Jaws | Without Ratchet | Straight | 21 cm 8.25 in |
| 117-C115-23-TI | Diamond Jaws | Without Ratchet | Straight | 23 cm 9 in    |
| 117-C125-18-TI | Diamond Jaws | With Ratchet    | Straight | 18 cm 7 in    |
| 117-C125-21-TI | Diamond Jaws | With Ratchet    | Straight | 21 cm 8.25 in |
| 117-C125-23-TI | Diamond Jaws | With Ratchet    | Straight | 23 cm 9 in    |
| 117-C126-18-TI | Diamond Jaws | With Ratchet    | Curved   | 18 cm 7 in    |
| 117-C126-21-TI | Diamond Jaws | With Ratchet    | Curved   | 21 cm 8.25 in |
| 117-C126-23-TI | Diamond Jaws | With Ratchet    | Curved   | 23 cm 9 in    |





**STILLE ERBJUDER** ett antal övriga instrument som komplement till huvudsortimentet. Här finns exempelvis unika produkter som STILLES artroskopikanyler, STILLE Hemostop och instrumentvårdsprodukter. Här kan man också hitta vårt utvalda sortiment av ortopediska implantat av högsta kvalitet, där Palmerstift, Wibergmärlor och Kirschner trådborrar ingår.



**STILLE OFFERS** a number of various instruments as a complement to the main offering. Included here are among other products, STILLE Arthroset, STILLE Hemostop and instrument care products. In this section we also offer a selected range of top quality orthopaedic implants, such as our well-known Palmer bone nails, Wiberg fracture staples and Kirschner wire drills.

Övriga instrument | Various instruments | Sonstige  
Instrumente | Altri strumenti | Instrumentos varios |  
様々な器具

Ergonomic design ensures  
comfortable grip and exact  
handling of delicate tissue.

All instruments are manufactured in  
selected top quality surgical steel.

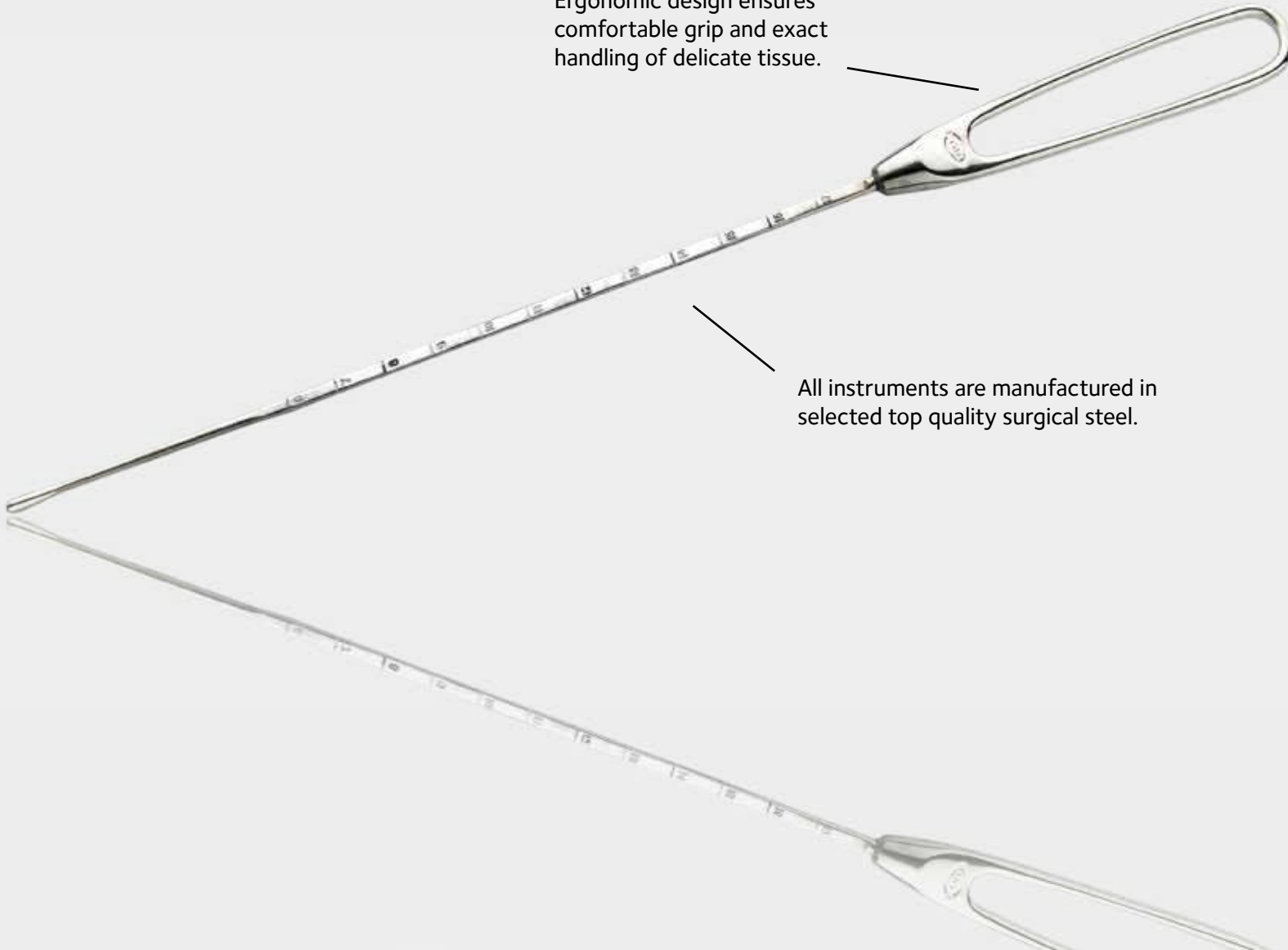



**Gillquist-STILLE artroskopisugrör | Gillquist-STILLE Arthroscopy Suction Tube**

Arthroscopy suction tube with mandrin.

119-10915 28 cm 11"

**Oretorp-STILLE sond | Oretorp-STILLE Probe**

Blunt ended probe for arthroscopy. Graduated shaft.

119-10928 Blunt 19.5 cm 7.75"



**STILLE sond | STILLE Probe**

Blunt ended probe for arthroscopy. Graduated shaft.

119-10928-1 Blunt 19.5 cm 7.75"





### STILLE uterusound | STILLE Uterine Sound

Uterine sound with malleable silver shaft. Graduated in cm. Drop-shaped tip.

119-28452      27 cm 10.75"



### Bergström-STILLE muskelbiopsi kanyl | Bergström-STILLE Muscle biopsy Cannula

Muscle biopsy cannula. Consists of a sharptipped, hollow outer needle with a small opening near the tip. A punch with a sharp edge fits tightly into the needle. The stylet is used for pushing out biopsy specimens from the punch.

119-29187-50      Diam 5 mm  
119-29187-60      Diam 6 mm

### STILLE Jameson skjutmått | STILLE Jameson Caliper

Caliper graduated 0-80 mm.

119-30025 0-80 mm 0-3" 9.5 cm 3.75"



### STILLE Castroviejo skjutmått | STILLE Castroviejo Caliper

Caliper with locking screw, graduated 0-20 mm.

119-30022 0-20 mm 8 cm 3.1"



### STILLE mätsticka | STILLE Ruler

Stainless steel ruler graduated in mm, 0-15 cm.

119-30010-15 15 cm 6"







### STILLE skalpellhandtag | STILLE Scalpel Handle

The most common scalpel handles made with highest precision.

|              |       |             |             |
|--------------|-------|-------------|-------------|
| 119-50010-3  | No 3  | Blade 10-15 | 12 cm 5"    |
| 119-50010-13 | No 3L | Blade 10-15 | 21 cm 8.25" |
| 119-50010-4  | No 4  | Blade 18-25 | 13 cm 5.25" |
| 119-50010-14 | No 4L | Blade 18-25 | 21 cm 8.25" |
| 119-50010-7  | No 7  | Blade 10-15 | 16 cm 6.25" |



### STILLE Barron skalpellhandtag | STILLE Barron Scalpel Handle

8-sided handle for precise handling and rotation.

|           |             |            |
|-----------|-------------|------------|
| 119-50012 | Blade 10-15 | 14 cm 5,5" |
|-----------|-------------|------------|

### STILLE skalpellhandtag | STILLE Scalpel Handle

Round handle guarantees precise finger tip control.

|           |             |               |
|-----------|-------------|---------------|
| 119-50015 | Blade 10-15 | 14.5 cm 5.75" |
|-----------|-------------|---------------|



### STILLE Mayo peanghängare | STILLE Mayo Safety Pin

Safety Pin with ball for better control of instruments on the tray.

119-50022 13,5 cm 5.25"

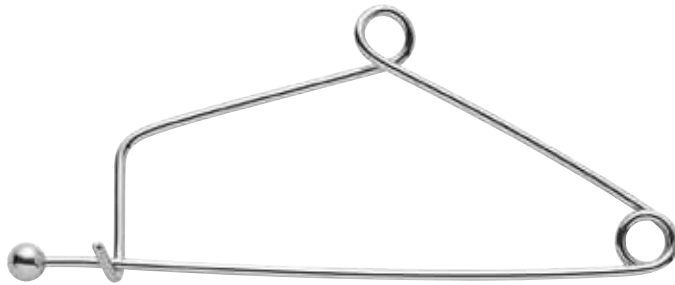

### STILLE Hemostop | STILLE Hemostop

Designed as an aid to stemming complicated venous and arterial bleeding during open surgery. Relatively long to be able to reach down into the pelvis.

119-60001 Ring diameter 18/28 mm 24 cm 9.5"





### STILLE instrumentolja | STILLE Instrument Oil

Instrument oil, package of 2 pcs á 50 ml.

119-78900-1 50 ml, package of 2 pcs

### STILLE rengöringsborste | STILLE Cleaning Brush

Cleaning brush for surgical instruments. Special stainless steel fine threaded, bristle diameter 0.12 mm, height 20 mm. Handy grip of plastic material. Autoclavable at 121C.

119-78950 20 cm 8", package 2 pcs



### STILLE Instrumentbricka | STILLE Instrument Sterilization Tray

Instrument tray for transport, sterilization and storage of delicate instruments. The trays are designed to assure proper penetration of sterilizing agent between the mat and the tray surface. Silicone mat included. Available in three different sizes. The trays are made to withstand common sterilization methods, including steam, gas, cold sterilization solutions, and temperatures up to 182°C/360 F.

|           |                 |                  |             |
|-----------|-----------------|------------------|-------------|
| 199-60010 | Micro tray      | 10.1x19x1.9 cm   | 4x7.5x0.75" |
| 199-60020 | Micro tray      | 15.2x25.4x1.9 cm | 6x10x0.75"  |
| 199-60030 | Instrument tray | 25.4x38.1x1.9 cm | 10x15x0.75" |

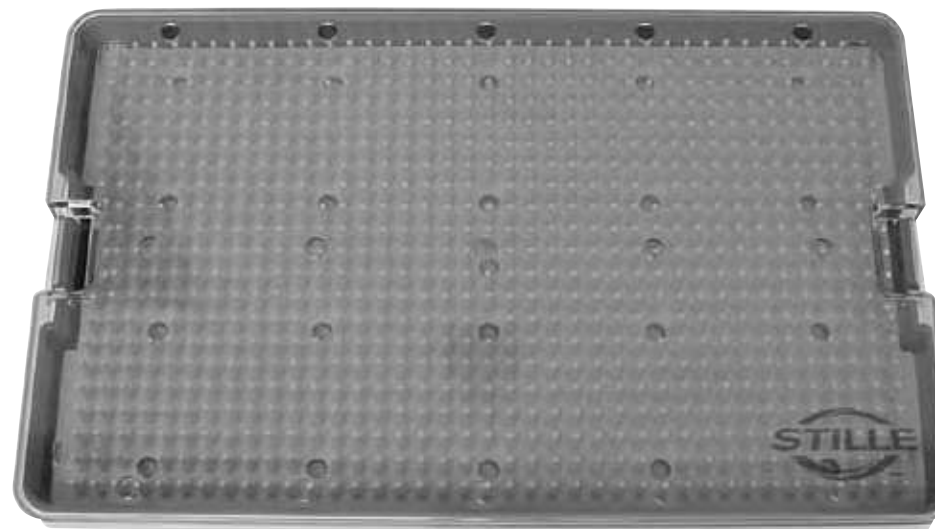

## STILLE-Gigli trådsåg | STILLE-Gigli Wire Saw

Gigli wire saw with superior cutting quality. Smooth joints between loops and wire. Available in three different lengths.

|              |                      |              |
|--------------|----------------------|--------------|
| 125-19150-30 | Pack of 25 pcs       | 30 cm 12"    |
| 125-19150-40 | Pack of 25 pcs       | 40 cm 15.75" |
| 125-19150-50 | Pack of 25 pcs       | 50 cm 20"    |
| 125-19160    | Handle               | 6.5 cm 2.5"  |
| 125-19170    | Guide/Dura Protector | 34 cm 13"    |

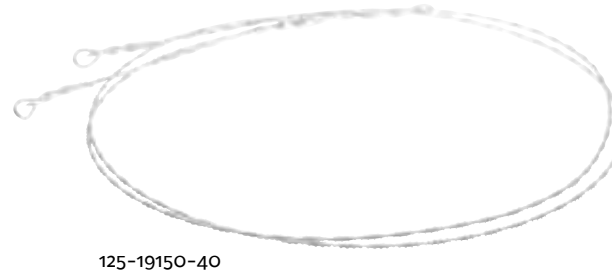

## STILLE artroskopikanylset | STILLE Arthroscopy Cannula Set

STILLE Arthroscopy cannula set is designed for maximal outflow through same diameter in inner diameter, drainage holes, connection and tubing - no interruptions. As an extra benefit a connector is added in all packages, offering the possibility to use it for intraarticular injection of saline before operating. Tubing 195 cm. Carton of 4 x 20 pcs, length 95 mm.

|              |         |           |           |
|--------------|---------|-----------|-----------|
| 415-2020     | Sterile | ID 2.5 mm | OD 4.0 mm |
| 415-2025-400 | Sterile | ID 4.0 mm | OD 5.4 mm |



## STILLE gipssåg | STILLE Plaster Cast Remover

A complete kit of plaster cast removers including wire saws in two lengths, stainless steel handles and plastic profiles.

|              |               |         |               |
|--------------|---------------|---------|---------------|
| 413-2500-2   | Metal Handle  |         |               |
| 413-2502-85  | Wire Saws     | 100 pcs | 85 cm 33.5"   |
| 413-2502-125 | Wire Saws     | 100 pcs | 125 cm 49.25" |
| 413-2504-85  | Soft Profiles | 100 pcs | 85 cm 33.5"   |
| 413-2504-125 | Soft Profiles | 100 pcs | 125 cm 49.25" |



## STILLE frakturtråd | STILLE Bone Wire

STILLE bone wire on 5 m coils. Not available in USA.

|              |           |        |                      |
|--------------|-----------|--------|----------------------|
| 121-18013-4  | Stainless | 0.4 mm | 5 m coils diam ,soft |
| 121-18013-5  | Stainless | 0.5 mm | 5 m coils diam, soft |
| 121-18013-6  | Stainless | 0.6 mm | 5 m coils diam, soft |
| 121-18013-7  | Stainless | 0.7 mm | 5 m coils diam, soft |
| 121-18013-8  | Stainless | 0.8 mm | 5 m coils diam, soft |
| 121-18013-9  | Stainless | 0.9 mm | 5 m coils diam, soft |
| 121-18013-10 | Stainless | 1.0 mm | 5 m coils diam, soft |



## Palmer-STILLE benstift | Palmer-STILLE Bone Nail

Round bone nails with diameter 1.5 mm. Not available in USA.

|              |               |       |              |
|--------------|---------------|-------|--------------|
| 121-18224-15 | Stainless     | Round | Length 15 mm |
| 121-18224-20 | Stainless     | Round | Length 20 mm |
| 121-18224-25 | Stainless     | Round | Length 25 mm |
| 121-18224-30 | Stainless     | Round | Length 30 mm |
| 121-18224-35 | Stainless     | Round | Length 35 mm |
| 121-18224-40 | Stainless     | Round | Length 40 mm |
| 121-18224-45 | Stainless     | Round | Length 45 mm |
| 121-18224-50 | Stainless     | Round | Length 50 mm |
| 121-18224-55 | Stainless     | Round | Length 55 mm |
| 121-18224-60 | Stainless     | Round | Length 60 mm |
| 121-18224-65 | Stainless     | Round | Length 65 mm |
| 121-18224-70 | Stainless     | Round | Length 70 mm |
| 121-18227    | Holder/Driver |       | 12 cm 5.7"   |
| 121-18229    | Impactor      |       | 17 cm 6.75"  |





## Wiberg-STILLE benmärla | Wiberg-STILLE Fracture Staple

Fracture staples in three different sizes. Not available in USA.

|              |               |             |
|--------------|---------------|-------------|
| 121-18251-16 | Stainless     | 16 mm       |
| 121-18251-19 | Stainless     | 19 mm       |
| 121-18251-22 | Stainless     | 22 mm       |
| 121-18255    | Holder/Driver | 17 cm 6.75" |

## STILLE Kirschner trådborr | STILLE Kirschner Wire Drill

Wire drills with lancet points with or without eye. Not available in USA.

|               |             |        |               |
|---------------|-------------|--------|---------------|
| 121-19357-11  | Without eye | 1.1 mm | 23.5 cm 9.25" |
| 121-19357-13  | Without eye | 1.3 mm | 23.5 cm 9.25" |
| 121-19357-15  | Without eye | 1.5 mm | 23.5 cm 9.25" |
| 121-19357-18  | Without eye | 1.8 mm | 23.5 cm 9.25" |
| 121-19357-20  | Without eye | 2.0 mm | 23.5 cm 9.25" |
| 121-19357-213 | With eye    | 1.3 mm | 23.5 cm 9.25" |
| 121-19357-215 | With eye    | 1.5 mm | 23.5 cm 9.25" |
| 121-19357-218 | With eye    | 1.8 mm | 23.5 cm 9.25" |
| 121-19357-220 | With eye    | 2.0 mm | 23.5 cm 9.25" |



**DR. HERBERT OLIVECRONA**, professor i neurokirurgi vid Karolinska institutet, pionjär inom neurokirurgi vid Serafimerlasarettet, läkare vid Sabbatsbergs sjukhus samt ledamot av Kungliga Vetenskapsakademien. Utvecklade flera instrument tillsammans med STILLE, såsom kyretter, peanger och pincetter.

**DR. HERBERT OLIVECRONA**, professor of neurosurgery at the Karolinska Institute, a pioneer in neurosurgery at the Serafimer Hospital, doctor at Sabbatsberg Hospital and member of the Royal Swedish Academy of Sciences. Developed several instruments in collaboration with STILLE, such as curettes, artery forceps and forceps.



# Numeriskt index | Numerical index | Nummernverzeichnis | Indice di numeri | Índice de números | 品番索引

| Art nr      | Page | Art nr      | Page | Art nr          | Page | Art nr          | Page | Art nr       | Page | Art nr      | Page | Art nr        | Page |
|-------------|------|-------------|------|-----------------|------|-----------------|------|--------------|------|-------------|------|---------------|------|
| <b>101</b>  |      | 101-8084-19 | 20   | 101-8166-2      | 38   | 101-8175-20     | 27   | 101-8411     | 44   | 102-9024    | 57   | 102-9318      | 61   |
| 101-8001    | 16   | 101-8085-15 | 21   | 101-8167        | 36   | 101-8175-20-C   | 27   | 101-8420     | 34   | 102-9025    | 57   | 102-9320      | 61   |
| 101-8002    | 16   | 101-8085-17 | 21   | 101-8167-1      | 36   | 101-8175-23     | 27   | 101-8425     | 44   | 102-9025-1  | 57   | 102-9322      | 61   |
| 101-8003    | 16   | 101-8085-19 | 21   | 101-8167-1-C    | 37   | 101-8175-23-C   | 27   | 101-8430-171 | 46   | 102-9027    | 54   | 102-9330      | 61   |
| 101-8004    | 16   | 101-8086-15 | 20   | 101-8167-151    | 36   | 101-8175-26     | 27   | 101-8430-172 | 46   | 102-9028    | 55   | 102-9340      | 61   |
| 101-8010    | 16   | 101-8086-17 | 20   | 101-8167-151-C  | 37   | 101-8175-26-C   | 27   | 101-8431-171 | 46   | 102-9030-13 | 57   | 102-9342      | 61   |
| 101-8010-1  | 16   | 101-8086-19 | 20   | 101-8167-152    | 38   | 101-8175-30     | 27   | 101-8431-172 | 46   | 102-9030-15 | 57   | 102-9354      | 61   |
| 101-8011    | 16   | 101-8087-15 | 21   | 101-8167-153D   | 39   | 101-8175-30-C   | 27   | 101-8433-20  | 46   | 102-9030-17 | 57   | 102-9460      | 60   |
| 101-8011-1  | 16   | 101-8087-17 | 21   | 101-8167-153D-C | 39   | 101-8175-33     | 27   | 101-8433-202 | 46   | 102-9030-20 | 57   | 102-9470      | 60   |
| 101-8015    | 16   | 101-8087-19 | 21   | 101-8167-153U   | 39   | 101-8176-15     | 27   | 101-8435-20  | 46   | 102-9030-25 | 57   | 102-9845-15   | 62   |
| 101-8015-1  | 16   | 101-8090    | 21   | 101-8167-153U-C | 39   | 101-8176-18     | 27   | 101-8435-202 | 46   | 102-9040-15 | 57   | 102-9845-20   | 62   |
| 101-8016    | 16   | 101-8092    | 21   | 101-8167-181    | 36   | 101-8176-20     | 27   | 101-8436-20  | 46   | 102-9040-17 | 57   | 102-9845-25   | 62   |
| 101-8016-1  | 16   | 101-8096-20 | 33   | 101-8167-181-C  | 37   | 101-8176-23     | 27   | 101-8440-201 | 47   | 102-9040-20 | 57   | 102-9846-20   | 63   |
| 101-8018-1  | 17   | 101-8096-23 | 33   | 101-8167-182    | 38   | 101-8176-26     | 27   | 101-8441-201 | 47   | 102-9040-25 | 57   | 102-9852-20   | 62   |
| 101-8019-1  | 17   | 101-8097-20 | 34   | 101-8167-2      | 38   | 101-8200-125    | 40   | 101-8442-171 | 47   | 102-9040-30 | 57   | 102-9852-25   | 62   |
| 101-8019-2  | 17   | 101-8097-23 | 34   | 101-8167-2-C    | 38   | 101-8200-25     | 40   | 101-8452     | 47   | 102-9050-13 | 55   | 102-9852-30   | 62   |
| 101-8020    | 18   | 101-8098-20 | 33   | 101-8170-1      | 36   | 101-8200-45     | 40   | 101-8456-171 | 48   | 102-9060-15 | 55   | 102-9855-20   | 62   |
| 101-8021    | 18   | 101-8098-23 | 33   | 101-8171-1      | 36   | 101-8200-60     | 40   | 101-8458-17  | 48   | 102-9060-17 | 55   | 102-9855-25   | 62   |
| 101-8021-1  | 18   | 101-8098-30 | 33   | 101-8172-18     | 24   | 101-8200-90     | 40   | 101-8458-172 | 48   | 102-9060-20 | 55   |               |      |
| 101-8022    | 18   | 101-8099-20 | 34   | 101-8172-23     | 24   | 101-8201-125    | 40   | 101-8458-20  | 48   | 102-9062-15 | 55   | <b>103</b>    |      |
| 101-8025    | 42   | 101-8099-23 | 34   | 101-8173-15     | 24   | 101-8201-25     | 40   | 101-8458-202 | 48   | 102-9062-17 | 55   | 103-10015-131 | 66   |
| 101-8031-1  | 17   | 101-8099-30 | 34   | 101-8173-15-C   | 25   | 101-8201-45     | 40   | 101-8459-20  | 48   | 102-9062-20 | 55   | 103-10026-121 | 66   |
| 101-8031-2  | 17   | 101-8100-15 | 21   | 101-8173-153D   | 26   | 101-8201-60     | 40   | 101-8460     | 35   | 102-9077-20 | 58   | 103-10028-121 | 66   |
| 101-8042-15 | 33   | 101-8102-15 | 21   | 101-8173-153D-C | 26   | 101-8201-90     | 40   | 101-8470     | 32   | 102-9078-20 | 58   | 103-10030-121 | 66   |
| 101-8043-15 | 33   | 101-8110    | 42   | 101-8173-153U   | 26   | 101-8378        | 30   | 101-8490     | 41   | 102-9244-15 | 59   | 103-10032-121 | 66   |
| 101-8047-13 | 33   | 101-8110-1  | 42   | 101-8173-153U-C | 26   | 101-8380-12     | 30   | 101-8490-2   | 41   | 102-9244-20 | 59   | 103-10032-181 | 66   |
| 101-8047-15 | 33   | 101-8115    | 42   | 101-8173-18     | 24   | 101-8380-121    | 30   | 101-8580     | 35   | 102-9244-25 | 59   | 103-10035-121 | 66   |
| 101-8048-15 | 33   | 101-8115-1  | 42   | 101-8173-18-C   | 25   | 101-8380-121-C  | 31   | 101-8584     | 50   | 102-9248-15 | 56   | 103-10037-121 | 66   |
| 101-8048-18 | 33   | 101-8120    | 43   | 101-8173-20     | 24   | 101-8380-122    | 32   | 101-8586-9   | 50   | 102-9248-20 | 56   | 103-10115-141 | 67   |
| 101-8060    | 18   | 101-8120-1  | 43   | 101-8174-15     | 25   | 101-8380-15     | 30   | 101-8595-18  | 50   | 102-9248-25 | 56   | 103-10117-141 | 67   |
| 101-8060-1  | 19   | 101-8122    | 43   | 101-8174-18     | 25   | 101-8380-151    | 30   | 101-8597-14  | 51   | 102-9252-20 | 56   | 103-10150-141 | 67   |
| 101-8060-2  | 19   | 101-8123    | 43   | 101-8174-20     | 25   | 101-8380-151-C  | 31   | 101-8604     | 45   | 102-9252-25 | 56   | 103-10152-141 | 67   |
| 101-8062    | 18   | 101-8123-1  | 43   | 101-8174-23     | 25   | 101-8380-152    | 32   | 101-8815-12  | 51   | 102-9252-30 | 56   | 103-10160-161 | 68   |
| 101-8062-1  | 19   | 101-8125    | 43   | 101-8174-26     | 25   | 101-8380-153D   | 31   |              |      | 102-9254    | 58   | 103-10162-161 | 68   |
| 101-8062-2  | 19   | 101-8138    | 22   | 101-8175-15     | 27   | 101-8380-153D-C | 31   | <b>102</b>   |      | 102-9255-20 | 58   | 103-10172     | 68   |
| 101-8080-15 | 19   | 101-8160    | 22   | 101-8175-15-C   | 27   | 101-8380-153U   | 31   | 102-9019     | 54   | 102-9255-25 | 58   | 103-10180-141 | 69   |
| 101-8080-17 | 19   | 101-8161    | 23   | 101-8175-152    | 28   | 101-8380-153U-C | 31   | 102-9020     | 57   | 102-9270-20 | 56   | 103-10180-161 | 69   |
| 101-8081-15 | 20   | 101-8162    | 22   | 101-8175-153D   | 28   | 101-8380-18     | 30   | 102-9020-1   | 57   | 102-9300    | 61   | 103-10180-181 | 69   |
| 101-8082-15 | 19   | 101-8163    | 23   | 101-8175-153D-C | 29   | 101-8380-181    | 30   | 102-9020-15  | 57   | 102-9302    | 61   | 103-10182-141 | 69   |
| 101-8082-17 | 19   | 101-8163-2  | 23   | 101-8175-153U   | 28   | 101-8380-181-C  | 31   | 102-9021     | 54   | 102-9304    | 61   | 103-10182-161 | 69   |
| 101-8083-15 | 20   | 101-8163-C  | 23   | 101-8175-153U-C | 29   | 101-8380-20     | 30   | 102-9021-1   | 54   | 102-9308    | 61   | 103-10182-181 | 69   |
| 101-8084-15 | 20   | 101-8164    | 49   | 101-8175-18     | 27   | 101-8380-201    | 30   | 102-9022     | 54   | 102-9312    | 61   | 103-10185     | 69   |
| 101-8084-17 | 20   | 101-8166    | 36   | 101-8175-18-C   | 27   | 101-8380-23     | 30   | 102-9022-15  | 54   | 102-9314    | 61   | 103-10185-161 | 69   |
|             |      | 101-8166-1  | 36   | 101-8175-182    | 28   | 101-8380-231    | 30   | 102-9023-12  | 54   | 102-9316    | 61   | 103-10187-141 | 69   |

| Art nr        | Page | Art nr        | Page | Art nr         | Page | Art nr        | Page | Art nr       | Page | Art nr        | Page | Art nr       | Page |
|---------------|------|---------------|------|----------------|------|---------------|------|--------------|------|---------------|------|--------------|------|
| 103-10187-161 | 69   | 104-15556     | 84   | <b>105</b>     |      | 105-17643-3-C | 112  | 107-12487    | 136  | 108-24935-35  | 151  | 111-20340-7  | 162  |
| 103-10190     | 70   | 104-15557     | 84   | 105-17643-4    | 111  | 105-17643-4   | 111  | 107-12488    | 136  | 108-24935-40  | 151  | 111-20340-8  | 162  |
| 103-10192     | 70   | 104-15558     | 84   | 105-13921-18   | 113  | 105-17643-4-C | 112  | 107-12489    | 136  | 108-24935-55  | 151  | 111-20350-10 | 162  |
| 103-10195     | 70   | 104-15559     | 84   | 105-13921-18-C | 113  | 105-17643-5   | 111  | 107-12490    | 136  | 108-24940-55  | 151  | 111-20350-12 | 162  |
| 103-10197     | 70   | 104-15560     | 85   | 105-13931-18   | 113  | 105-17643-5-C | 112  | 107-12491    | 134  | 108-25011-1   | 142  | 111-20350-7  | 162  |
| 103-10200-161 | 70   | 104-15560-2   | 85   | 105-13931-18-C | 113  | 105-17644-2   | 111  | 107-12563    | 132  | 108-25012-10  | 142  | 111-20350-8  | 162  |
| 103-10200-181 | 70   | 104-15561-141 | 85   | 105-13941-18   | 114  | 105-17644-2-C | 112  | 107-13120-15 | 133  | 108-25012-2   | 142  | 111-20502-10 | 163  |
| 103-10202-161 | 70   | 104-15561-161 | 85   | 105-13941-18-C | 114  | 105-17644-3   | 111  | 107-13120-21 | 133  | 108-25012-5   | 142  | 111-20502-12 | 163  |
| 103-10202-181 | 70   | 104-15561-181 | 85   | 105-13955-18   | 115  | 105-17644-3-C | 112  | 107-13130-15 | 134  | 108-25012-7   | 142  | 111-20502-2  | 163  |
| 103-10205-161 | 71   | 104-15561-201 | 85   | 105-13955-18-C | 115  | 105-17644-4   | 111  | 107-13130-19 | 134  | 108-25031-3   | 143  | 111-20502-3  | 163  |
| 103-10205-181 | 71   | 104-15561-251 | 85   | 105-13956-18   | 115  | 105-17644-4-C | 112  | 107-13130-25 | 134  | 108-25031-5   | 143  | 111-20502-4  | 163  |
| 103-10207-161 | 71   | 104-15562-161 | 86   | 105-13957-18   | 115  | 105-17644-5   | 111  | 107-13280    | 137  | 108-25031-7   | 143  | 111-20502-5  | 163  |
| 103-10207-181 | 71   | 104-15562-181 | 86   | 105-13957-18-C | 115  | 105-17644-5-C | 112  | 107-13290    | 138  | 108-25940     | 148  | 111-20502-6  | 163  |
| 103-10210-201 | 71   | 104-15562-201 | 86   | 105-16015      | 96   |               |      |              |      | 108-26011     | 148  | 111-20502-7  | 163  |
| 103-10210-241 | 71   | 104-15562-241 | 86   | 105-16020      | 97   | <b>107</b>    |      | <b>108</b>   |      | 108-26015     | 149  | 111-20502-8  | 163  |
| 103-10212-201 | 71   | 104-15562-271 | 86   | 105-16020-1    | 97   | 107-10565     | 118  | 108-23780-25 | 153  | 108-26037-19  | 149  | 111-20503-2  | 163  |
| 103-10212-241 | 71   | 104-15562-301 | 86   | 105-16150      | 108  | 107-10571-241 | 119  | 108-23780-35 | 153  | 108-26037-22  | 149  | 111-20503-3  | 163  |
| 103-10212-301 | 71   | 104-15565-151 | 86   | 105-16152      | 108  | 107-10581-241 | 119  | 108-23780-45 | 153  | 108-26037-25  | 149  | 111-20503-4  | 163  |
| 103-10215-201 | 72   | 104-15565-181 | 86   | 105-16215      | 109  | 107-10655     | 120  | 108-24110    | 142  | 108-26038     | 150  | 111-20503-5  | 163  |
| 103-10215-241 | 72   | 104-15565-201 | 86   | 105-16223      | 109  | 107-10656     | 120  | 108-24112    | 142  | 108-26046-10  | 150  | 111-20503-6  | 163  |
| 103-10217-201 | 72   | 104-15565-231 | 86   | 105-16225      | 110  | 107-10665     | 120  | 108-24116    | 143  | 108-26046-12  | 150  | 111-21305-10 | 178  |
| 103-10217-241 | 72   | 104-15566-151 | 87   | 105-16225      | 110  | 107-10670     | 120  | 108-24117    | 143  | 108-26046-14  | 150  | 111-21305-12 | 178  |
| 103-10220-201 | 72   | 104-15566-181 | 87   | 105-16510      | 98   | 107-10671     | 120  | 108-24320    | 144  | 108-26046-8   | 150  | 111-21305-4  | 178  |
| 103-10222-201 | 72   | 104-15566-201 | 87   | 105-16512      | 98   | 107-10695     | 123  | 108-24380    | 145  | 108-26048-7   | 144  | 111-21305-6  | 178  |
| 103-10240-161 | 73   | 104-15566-231 | 87   | 105-16811      | 99   | 107-10696     | 123  | 108-24385-15 | 145  | 108-26252     | 55   | 111-21305-8  | 178  |
| 103-10260-191 | 73   | 104-15571     | 88   | 105-17030      | 100  | 107-10697     | 123  | 108-24385-8  | 145  | 108-26253     | 155  | 111-21306-10 | 178  |
| 103-10262-191 | 73   | 104-15573-161 | 88   | 105-17210      | 101  | 107-10825     | 121  | 108-24400-1  | 146  | 108-26254     | 155  | 111-21306-2  | 178  |
| 103-10310     | 74   | 104-15573-181 | 88   | 105-17211      | 101  | 107-10826     | 121  | 108-24400-2  | 146  | 108-26255     | 155  | 111-21306-4  | 178  |
| 103-10411-201 | 74   | 104-15573-201 | 88   | 105-17215      | 101  | 107-10840     | 124  | 108-24400-3  | 146  | 108-26256     | 155  | 111-21306-6  | 178  |
| 103-10413-211 | 75   | 104-15585-161 | 89   | 105-17216      | 102  | 107-10841     | 124  | 108-24401-2  | 146  | 108-26257     | 155  | 111-21306-8  | 178  |
| 103-10413-241 | 75   | 104-15585-181 | 89   | 105-17217      | 102  | 107-10842     | 124  | 108-24401-3  | 146  | 108-26261     | 155  | 111-21310-10 | 179  |
| 103-10416     | 77   | 104-15585-221 | 89   | 105-17220      | 102  | 107-10845     | 127  | 108-24402-2  | 146  | 108-26262     | 155  | 111-21310-12 | 179  |
| 103-10420-201 | 76   | 104-15585-251 | 89   | 105-17230      | 103  | 107-10846     | 128  | 108-24402-3  | 146  | 108-26610     | 156  | 111-21310-15 | 179  |
| 103-10421-211 | 76   | 104-15586     | 89   | 105-17250      | 104  | 107-10849     | 128  | 108-24403-2  | 146  | 108-26615     | 156  | 111-21310-6  | 179  |
| 103-10422-211 | 76   | 104-15590-121 | 90   | 105-17260      | 105  | 107-10860     | 126  | 108-24403-3  | 146  | 108-26846-10  | 150  | 111-21310-8  | 179  |
| 103-10423-1   | 78   | 104-15590-131 | 90   | 105-17261      | 105  | 107-10861     | 126  | 108-24680-1  | 146  | 108-26846-12  | 150  | 111-21312-10 | 185  |
| 103-10423-2   | 78   | 104-15590-171 | 90   | 105-17265      | 106  | 107-10862     | 126  | 108-24680-2  | 146  | 108-26846-14  | 150  | 111-21312-12 | 185  |
| 103-10423-3   | 78   | 104-15590-181 | 90   | 105-17266      | 106  | 107-10871     | 125  | 108-24680-3  | 146  | 108-26846-8   | 150  | 111-21312-15 | 185  |
| 103-10423-4   | 78   | 104-15621-179 | 90   | 105-17267      | 107  | 107-10872     | 122  | 108-24680-4  | 146  | 108-26865     | 152  | 111-21312-6  | 185  |
| 103-10425     | 76   | 104-15621-209 | 90   | 105-17268      | 107  | 107-10873     | 122  | 108-24682-2  | 146  | 108-26931     | 157  | 111-21312-8  | 185  |
| 103-10428-151 | 78   | 104-15665-151 | 87   | 105-17269      | 107  | 107-10876     | 122  | 108-24682-3  | 146  | 108-26931-100 | 157  | 111-21315-10 | 186  |
| 103-10430-241 | 77   | 104-15777     | 91   | 105-17642-2    | 111  | 107-10880     | 129  | 108-24682-4  | 146  | 108-26931-80  | 157  | 111-21315-12 | 186  |
| <b>104</b>    |      | 104-15785     | 91   | 105-17642-2-C  | 112  | 107-10889     | 130  | 108-24805    | 154  | 108-27011-1   | 158  | 111-21315-15 | 186  |
| 104-15140     | 92   | 104-15832     | 93   | 105-17642-3    | 111  | 107-10910     | 131  | 108-24808    | 147  | 108-27011-2   | 158  | 111-21315-6  | 186  |
| 104-15542     | 83   | 104-15835     | 93   | 105-17642-3-C  | 112  | 107-10912     | 131  | 108-24812-7  | 147  | 108-27011-3   | 158  | 111-21315-8  | 186  |
| 104-15545     | 83   | 104-15854     | 93   | 105-17642-4    | 111  | 107-10916     | 132  | 108-24814-10 | 147  | 108-27021-2   | 158  | 111-21330-10 | 179  |
| 104-15546     | 83   | 104-15855     | 93   | 105-17642-4-C  | 112  | 107-12370-20  | 132  | 108-24814-15 | 147  |               |      | 111-21330-12 | 179  |
| 104-15549-131 | 83   | 104-15856     | 93   | 105-17642-5    | 111  | 107-12478     | 135  | 108-24814-20 | 147  | <b>111</b>    |      | 111-21330-15 | 179  |
| 104-15550     | 84   |               |      | 105-17642-5-C  | 112  | 107-12479     | 135  | 108-24816-20 | 147  | 111-19381     | 187  | 111-21330-20 | 179  |
| 104-15551     | 84   |               |      | 105-17643-2    | 111  | 107-12485     | 136  | 108-24930-20 | 151  | 111-20340-10  | 162  | 111-21330-25 | 179  |
|               |      |               |      | 105-17643-2-C  | 112  | 107-12486     | 136  | 108-24930-30 | 151  | 111-20340-5   | 162  | 111-21330-30 | 179  |
|               |      |               |      | 105-17643-3    | 111  |               |      |              |      |               |      |              |      |

| Art nr       | Page | Art nr       | Page | Art nr         | Page | Art nr         | Page | Art nr         | Page | Art nr        | Page |
|--------------|------|--------------|------|----------------|------|----------------|------|----------------|------|---------------|------|
| 111-21335-10 | 186  | 111-22140-6  | 169  | 117-A113-18    | 194  | 117-B140-21-TI | 199  | 117-C125-15    | 201  | 121-18224-15  | 214  |
| 111-21335-12 | 186  | 111-22150    | 164  | 117-A113-21    | 194  | 117-B140-23    | 197  | 117-C125-18    | 201  | 121-18224-20  | 214  |
| 111-21335-15 | 186  | 111-22155-10 | 164  | 117-A120-125   | 194  | 117-B140-23-TI | 199  | 117-C125-18-TI | 203  | 121-18224-25  | 214  |
| 111-21335-20 | 186  | 111-22155-13 | 164  | 117-A120-25    | 194  | 117-B150-15    | 197  | 117-C125-21    | 201  | 121-18224-30  | 214  |
| 111-21441-15 | 180  | 111-22155-19 | 164  | 117-A120-45    | 194  | 117-B150-18    | 197  | 117-C125-21-TI | 203  | 121-18224-35  | 214  |
| 111-21441-20 | 180  | 111-22155-25 | 164  | 117-A120-60    | 194  | 117-B150-21    | 197  | 117-C125-23    | 201  | 121-18224-40  | 214  |
| 111-21441-25 | 180  | 111-22158-9  | 165  | 117-A120-90    | 194  | 117-B160-18    | 197  | 117-C125-23-TI | 203  | 121-18224-45  | 214  |
| 111-21441-30 | 180  | 111-22160    | 165  | 117-A121-125   | 194  | 117-B160-18-TI | 199  | 117-C126-15    | 201  | 121-18224-50  | 214  |
| 111-21441-40 | 180  | 111-22171-12 | 166  | 117-A121-25    | 194  | 117-B160-21    | 197  | 117-C126-18    | 201  | 121-18224-55  | 214  |
| 111-21441-7  | 180  | 111-22171-4  | 166  | 117-A121-45    | 194  | 117-B160-21-TI | 199  | 117-C126-18-TI | 203  | 121-18224-60  | 214  |
| 111-21442-15 | 180  | 111-22171-7  | 166  | 117-A121-60    | 194  | 117-B165-18    | 197  | 117-C126-21    | 201  | 121-18224-65  | 214  |
| 111-21442-20 | 180  | 111-22171-9  | 166  | 117-A121-90    | 194  | 117-B165-21    | 197  | 117-C126-21-TI | 203  | 121-18224-70  | 214  |
| 111-21442-25 | 180  | 111-22350    | 166  | 117-A125-125   | 195  | 117-C110-15    | 200  | 117-C126-23    | 201  | 121-18227     | 214  |
| 111-21442-7  | 180  | 111-22370    | 167  | 117-A125-25    | 195  | 117-C110-18    | 200  | 117-C126-23-TI | 203  | 121-18229     | 214  |
| 111-21450-10 | 181  | 111-22385-4  | 167  | 117-A125-45    | 195  | 117-C110-18-TI | 202  | 117-C130-19    | 201  | 121-18251-16  | 215  |
| 111-21450-11 | 181  | 111-22440-18 | 173  | 117-A125-60    | 195  | 117-C110-21    | 200  | 117-C130-23    | 201  | 121-18251-19  | 215  |
| 111-21450-12 | 181  | 111-22440-24 | 173  | 117-A125-90    | 195  | 117-C110-21-TI | 202  | 117-C130-25    | 201  | 121-18251-22  | 215  |
| 111-21450-2  | 181  | 111-22442-19 | 173  | 117-B110-15    | 196  | 117-C110-23    | 200  | 117-C140-19    | 201  | 121-18255     | 215  |
| 111-21450-3  | 181  | 111-22442-24 | 173  | 117-B110-18    | 196  | 117-C110-23-TI | 202  | 117-C140-23    | 201  | 121-19357-11  | 215  |
| 111-21450-4  | 181  | 111-22444    | 173  | 117-B110-21    | 196  | 117-C111-15    | 200  | 117-C140-25    | 201  | 121-19357-13  | 215  |
| 111-21450-5  | 181  | 111-22446    | 173  | 117-B110-23    | 196  | 117-C111-15-TI | 202  |                |      | 121-19357-15  | 215  |
| 111-21450-6  | 181  | 111-22520-4  | 168  | 117-B111-15    | 196  | 117-C111-18    | 200  | <b>119</b>     |      | 121-19357-18  | 215  |
| 111-21450-7  | 181  | 111-22522-4  | 169  | 117-B111-18    | 196  | 117-C111-18-TI | 202  | 119-10915      | 206  | 121-19357-20  | 215  |
| 111-21450-8  | 181  | 111-22532    | 170  | 117-B111-21    | 196  | 117-C111-21    | 200  | 119-10928      | 206  | 121-19357-213 | 215  |
| 111-21450-9  | 181  | 111-22550-10 | 170  | 117-B120-15    | 196  | 117-C111-21-TI | 202  | 119-10928-1    | 206  | 121-19357-215 | 215  |
| 111-21456-10 | 182  | 111-22550-8  | 170  | 117-B120-18    | 196  | 117-C111-23    | 200  | 119-28452      | 207  | 121-19357-218 | 215  |
| 111-21456-12 | 182  | 111-22563-3  | 172  | 117-B120-18-TI | 198  | 117-C115-15    | 200  | 119-29187-50   | 207  | 121-19357-220 | 215  |
| 111-21456-2  | 182  | 111-22563-6  | 172  | 117-B120-21    | 196  | 117-C115-18    | 200  | 119-29187-60   | 207  |               |      |
| 111-21456-4  | 182  | 111-22565-6  | 171  | 117-B120-21-TI | 198  | 117-C115-18-TI | 203  | 119-30010-15   | 208  | <b>125</b>    |      |
| 111-21456-6  | 182  | 111-22565-8  | 171  | 117-B120-23    | 196  | 117-C115-21    | 200  | 119-30022      | 208  | 125-19150-30  | 212  |
| 111-21456-8  | 182  | 111-22567-9  | 171  | 117-B120-23-TI | 198  | 117-C115-21-TI | 203  | 119-30025      | 208  | 125-19150-40  | 212  |
| 111-21460-10 | 182  | 111-22568-18 | 171  | 117-B120-25-TI | 198  | 117-C115-23    | 200  | 119-50010-13   | 209  | 125-19150-50  | 212  |
| 111-21460-15 | 182  | 111-22569-18 | 171  | 117-B121-15    | 196  | 117-C115-23-TI | 203  | 119-50010-14   | 209  | 125-19160     | 212  |
| 111-21460-20 | 182  | 111-22569-24 | 171  | 117-B121-18    | 196  | 117-C116-15    | 200  | 119-50010-3    | 209  | 125-19170     | 212  |
| 111-21477-10 | 184  | 111-22635    | 172  | 117-B121-18-TI | 198  | 117-C116-18    | 200  | 119-50010-4    | 209  |               |      |
| 111-21477-12 | 184  | 111-22860    | 174  | 117-B121-21    | 196  | 117-C116-21    | 200  | 119-50010-7    | 209  | <b>199</b>    |      |
| 111-21477-4  | 184  | 111-22861    | 174  | 117-B121-21-TI | 198  | 117-C116-23    | 200  | 119-50012      | 209  | 199-60010     | 211  |
| 111-21477-6  | 184  | 111-22862    | 174  | 117-B121-23-TI | 198  | 117-C120-15    | 200  | 119-50015      | 209  | 199-60020     | 211  |
| 111-21477-8  | 184  | 111-22863    | 174  | 117-B121-25-TI | 198  | 117-C120-18    | 200  | 119-50022      | 210  | 199-60030     | 211  |
| 111-21501-1  | 183  |              |      | 117-B130-18    | 196  | 117-C120-18-TI | 202  | 119-60001      | 210  |               |      |
| 111-21501-2  | 183  | <b>117</b>   |      | 117-B130-18-TI | 198  | 117-C120-21    | 200  | 119-78900-1    | 211  | <b>413</b>    |      |
| 111-21501-3  | 183  | 117-A110-15  | 194  | 117-B130-21    | 196  | 117-C120-21-TI | 202  | 119-78950      | 211  | 413-2500-2    | 213  |
| 111-21517-10 | 183  | 117-A110-18  | 194  | 117-B130-21-TI | 198  | 117-C120-23    | 200  |                |      | 413-2502-125  | 213  |
| 111-21517-12 | 183  | 117-A110-21  | 194  | 117-B130-23    | 196  | 117-C120-23-TI | 202  | <b>121</b>     |      | 413-2502-85   | 213  |
| 111-21517-14 | 183  | 117-A111-15  | 194  | 117-B131-18    | 196  | 117-C121-15    | 200  | 121-18013-10   | 214  | 413-2504-125  | 213  |
| 111-21820    | 188  | 117-A111-18  | 194  | 117-B131-18-TI | 198  | 117-C121-18    | 200  | 121-18013-4    | 214  | 413-2504-85   | 213  |
| 111-21825    | 189  | 117-A111-21  | 194  | 117-B131-21    | 196  | 117-C121-18-TI | 202  | 121-18013-5    | 214  |               |      |
| 111-21825-5  | 189  | 117-A112-15  | 194  | 117-B131-21-TI | 198  | 117-C121-21    | 200  | 121-18013-6    | 214  |               |      |
| 111-21920    | 189  | 117-A112-18  | 194  | 117-B140-18    | 197  | 117-C121-21-TI | 202  | 121-18013-7    | 214  | <b>415</b>    |      |
| 111-21920-5  | 189  | 117-A112-21  | 194  | 117-B140-18-TI | 199  | 117-C121-23    | 200  | 121-18013-8    | 214  | 415-2020      | 213  |
| 111-22140-4  | 169  | 117-A113-15  | 194  | 117-B140-21    | 197  | 117-C121-23-TI | 202  | 121-18013-9    | 214  | 415-2025-400  | 213  |



**DR. CLARENCE CRAFOORD**, professor i thoraxkirurgi vid Karolinska institutet samt överläkare vid Sabbatsbergs sjukhus. En pionjär inom thoraxkirurgi som genomförde världens första operation av kärlmissbildning vid medfött hjärtfel. Utvecklade tillsammans med STILLE, bland annat pincetter och peanger som än idag bär hans namn.

**DR. CLARENCE CRAFOORD**, professor of thoracic surgery at the Karolinska Institute and Chief Physician at Sabbatsberg Hospital. A pioneer in thoracic surgery who conducted the world's first operation for vascular malformation of congenital heart defects. Developed in collaboration with STILLE forceps and artery forceps, which still bear his name.

# Alfabetiskt register

| Produktnamn  | Sida | Produktnamn                            | Sida | Produktnamn  | Sida | Produktnamn  | Sida |
|--|------|--|------|--|------|--|------|
| <b>A</b>   |      | <b>D</b>                               |      | <b>H</b>   |      | <b>L</b>   |      |
| Adlercreutz STILLE pincett                                   | 56   | Dandy STILLE peang                     | 74   | Hake STILLE  | 146  | Lambert-Kay STILLE aorta anastomosklämmare               | 127  |
| Adson STILLE anatomisk pincett                               | 57   | Davis STILLE SuperCut XE Face-lift sax | 47   | Halsey STILLE nålförare                              | 85   | Lambotte STILLE miniosteotom                             | 181  |
| Adson STILLE peang   | 73   | De Bakey STILLE kärlpincett            | 61   | Halsted-Mosquito STILLE gracil peang                 | 66   | Lambotte STILLE osteotom                                 | 180  |
| Adson STILLE pincett   | 54   | De Bakey STILLE kärlpincett            | 61   | Halsted-Mosquito STILLE peang                        | 66   | Lambotte STILLE osteotom                                 | 180  |
| Adson STILLE självhållande hake                              | 156  | De Bakey STILLE kärlpincett            | 61   | Halsted-Mosquito STILLE peang                        | 66   | Lambotte STILLE raspatorium                              | 165  |
| Adson-Brown STILLE pincett                                   | 54   | De Bakey STILLE kärlpincett            | 61   | Halsted-Mosquito STILLE peang                        | 66   | Lambåhake Stille-Al Husseiny                             | 143  |
| Adson-Callison STILLE pincett                                | 54   | Deaver STILLE hake                     | 149  | Halsted-Mosquito STILLE peang                        | 66   | Langenbeck STILLE elevatorium                            | 170  |
| Allis STILLE fattningstång                                   | 133  | DeBakey STILLE aorta aneurysmklämmare  | 128  | Halsted-Mosquito STILLE peang                        | 66   | Langenbeck STILLE hake                                   | 147  |
| Allis STILLE fattningstång                                   | 134  | DeBakey STILLE mikropincett            | 197  | Halsted-Mosquito STILLE peang                        | 66   | Leksell STILLE gougetång                                 | 105  |
| Alm STILLE hake  | 155  | DeBakey STILLE mikropincett            | 197  | Hammar STILLE  | 188  | Leksell STILLE gougetång                                 | 106  |
| Anastomosklämmare STILLE                                     | 126  | Derf STILLE nålförare                  | 3    | Hammar STILLE  | 189  | Leriche STILLE peang                                     | 70   |
| Anatomisk pincett STILLE                                     | 57   | Desmarres STILLE ögonlockshake         | 150  | Hammar STILLE  | 89   | Lexer STILLE osteotom                                    | 182  |
| Anatomisk pincett STILLE                                     | 57   | Dissektionssax STILLE-Mayo             | 20   | Handosteotom STILLE                                  | 182  | Ligaturklämmare STILLE-Ehrén                             | 78   |
| Artroskopikanylset STILLE                                    | 213  | Dissektionssax STILLE-Mayo SuperCut XE | 21   | Heiss STILLE peang                                   | 76   | Lister STILLE TC bandagesax                              | 50   |
| Artär- och ligaturklämmare STILLE                            | 78   | Dissektor STILLE                       | 173  | Hemostop STILLE                                      | 210  | Littauer STILLE sutursax                                 | 51   |
| Aston STILLE SuperCut XE Face-lift sax                       | 47   | Doyen STILLE bukhake                   | 151  | Hohmann STILLE elevatorium                           | 171  | Littler STILLE trådföringssax                            | 49   |
| Aufricht STILLE nåshake                                      | 148  | DUO-GRIP nålförare STILLE-Frimand      | 87   | Howarth STILLE näsraspatorium                        | 167  | Love STILLE nervhake                                     | 144  |
| <b>B</b>   |      | Duval STILLE fattningstång             | 132  | <b>I</b>   |      | Love-Gruenwald STILLE bittång                            | 113  |
| Babcock STILLE fattningstång                                 | 132  | <b>E</b>                               |      | Instrumentbricka STILLE                              | 211  | Luer-STILLE gougetång                                    | 103  |
| Baby Mayo STILLE dissektionssax                              | 21   | Elevatorium STILLE                     | 172  | Instrumentolja STILLE                                | 211  | <b>M</b>   |      |
| Baby Metzenbaum STILLE Diamond SuperCut dissektionssax       | 23   | Ericsson-STILLE carotisklämmare        | 129  | Irispincett STILLE                                   | 60   | Maier STILLE tvättång                                    | 135  |
| Baby Metzenbaum STILLE dissektionssax                        | 22   | Ericsson-STILLE carotisklämmare        | 129  | <b>J</b>   |      | Matarasso STILLE SuperCut XE ergonomisk Face-lift sax    | 48   |
| Baby Metzenbaum STILLE SuperCut XE dissektionssax            | 23   | Extraktionstång STILLE                 | 97   | Jabaley STILLE dissektionssax                        | 18   | Matarasso STILLE SuperCut XE Face-lift sax               | 48   |
| Baby Metzenbaum STILLE SuperCut XE ergonomisk dissektionssax | 23   | <b>F</b>                               |      | Jabaley STILLE SuperCut XE dissektionssax            | 19   | Mathieu STILLE nålförare                                 | 90   |
| Backhaus STILLE dukklämmare                                  | 131  | Finochietto STILLE revbensspidare      | 157  | Jabaley STILLE SuperCut XE ergonomisk dissektionssax | 19   | Mayo STILLE dissektionssax                               | 19   |
| Barron STILLE skalpellhandtag                                | 209  | Foerster STILLE ringtång               | 136  | Jameson STILLE skjutmått                             | 208  | Mayo STILLE peanghängare                                 | 210  |
| Benavbitare STILLE   | 98   | Fomon STILLE nåssax                    | 42   | Joseph STILLE hudhake                                | 42   | Mayo STILLE SuperCut XE dissektionssax                   | 20   |
| Benavbitare STILLE   | 98   | Fomon STILLE rasp                      | 174  | Joseph STILLE nåssax                                 | 42   | Mayo-Harrington STILLE operationssax                     | 33   |
| Benavbitare STILLE   | 99   | Fomon STILLE SuperCut XE nåssax        | 44   | Joseph STILLE raspatorium                            | 167  | Mayo-Harrington STILLE SuperCut XE operationssax         | 34   |
| Bengolea STILLE peang  | 72   | Frakturtråd STILLE                     | 214  | Joseph STILLE SuperCut XE nåssax                     | 42   | Mayo-Hegar STILLE kraftig nålförare                      | 86   |
| Bergström-STILLE muskelbiopsi kanyl                          | 207  | Freer STILLE elevatorium               | 169  | <b>K</b>   |      | Mayo-Hegar STILLE nålförare                              | 85   |
| Beyer STILLE gougetång                                       | 100  | <b>G</b>                               |      | Kaye STILLE dissektionssax                           | 18   | Mayo-Noble STILLE dissektionssax                         | 21   |
| Beyer STILLE gougetång                                       | 101  | Gillies STILLE hudhake                 | 142  | Kaye STILLE nålförare                                | 91   | McIndoe STILLE anatomisk pincett                         | 57   |
| Björk-STILLE diatermipincetter                               | 62   | Gillies STILLE nålförare               | 84   | Kaye STILLE SuperCut XE dissektionssax               | 18   | Mejsel STILLE  | 185  |
| Björk-STILLE knutpincett                                     | 63   | Gillies STILLE nålförare               | 84   | Kelly STILLE peang                                   | 67   | Metzenbaum Stille Diamond SuperCut dissektionssax        | 27   |
| Boyd-STILLE tonsillsax                                       | 34   | Gillies STILLE pincett                 | 54   | Kelly-Rankin STILLE peang                            | 68   | Metzenbaum STILLE dissektionssax                         | 25   |
| Brösthake STILLE   | 150  |  |      | Kerrison STILLE laminektomistans                     | 111  | Metzenbaum STILLE gracil Diamond SuperCut dissektionssax | 25   |
| <b>C</b>   |      |  |      | Kerrison STILLE laminektomistans                     | 112  | Metzenbaum STILLE gracil dissektionssax                  | 24   |
| Carlens STILLE Tracheotomihake                               | 154  |  |      | Kilner STILLE nålförare                              | 83   | Metzenbaum STILLE gracil SuperCut XE dissektionssax      | 24   |
| Caspar STILLE bittång  | 115  |  |      | Kirschner STILLE trådborr                            | 215  | Metzenbaum STILLE SuperCut XE dissektionssax             | 27   |
| Castroviejo STILLE skjutmått                                 | 208  |  |      | Kleinert-Kutz STILLE hudhake                         | 143  | Metzenbaum STILLE SuperCut XE ergonomisk dissektionssax  | 28   |
| Christophe-STILLE peang                                      | 68   |  |      | Kocher STILLE bukspatel                              | 153  | Metzenbaum Stille-Ekberg Diamond SuperCut                |      |
| Cinelli STILLE osteotom                                      | 183  |  |      |  |      |  |      |
| Cobb STILLE raspatorium                                      | 164  |  |      |  |      |  |      |
| Colonklämmare STILLE   | 118  |  |      |  |      |  |      |
| Converse STILLE nålförare                                    | 91   |  |      |  |      |  |      |
| Converse STILLE nåshake                                      | 149  |  |      |  |      |  |      |

| Produktnamn                                      | Sida |
|--|------|
| ergonomisk dissektionssax                        | 29   |
| Metzenbaum Stille-Ekberg gracil Diamond SuperCut |      |
| ergonomisk dissektionssax                        | 26   |
| Metzenbaum Stille-Ekberg gracil SuperCut         |      |
| ergonomisk dissektionssax                        | 26   |
| Metzenbaum Stille-Ekberg SuperCut                |      |
| ergonomisk dissektionssax                        | 28   |
| Mikro klopincett STILLE                          | 197  |
| Mikrokärlsax STILLE SuperCut                     | 194  |
| Mikrokärlsax STILLE SuperCut                     | 195  |
| Mikro nålförare STILLE                           | 200  |
| Mikro nålförare STILLE                           | 200  |
| Mikro nålförare STILLE                           | 200  |
| Mikro nålförare STILLE                           | 201  |
| Mikro nålförare STILLE                           | 201  |
| Mikro ringpincett STILLE                         | 197  |
| Mikropincett STILLE                              | 196  |
| Mikropincett STILLE                              | 196  |
| Mikropincett STILLE                              | 196  |
| Mikrosax STILLE SuperCut                         | 194  |
| Mini tangential occlusionsklämmare STILLE        | 123  |
| Mini universalklämmare STILLE                    | 120  |
| Mini universalklämmare STILLE                    | 120  |
| Mini-Hohmann STILLE elevatorium                  | 171  |
| Moberg STILLE hake                               | 145  |
| Mätsticka STILLE                                 | 208  |
| <b>N</b>   |      |
| Neivert STILLE osteotom                          | 183  |
| Nervhake STILLE                                  | 144  |
| New Orleans STILLE nålförare                     | 88   |
| Nålförare STILLE                                 | 89   |
| Nålförare STILLE                                 | 89   |
| Näselevatorium STILLE                            | 169  |
| Näsraspatorium STILLE                            | 168  |
| Nässax STILLE SuperCut XE                        | 44   |
| <b>O</b>   |      |
| Olivecrona STILLE peang                          | 73   |
| Olivecrona STILLE raspatorium                    | 164  |
| Olivecrona-STILLE durapincett                    | 59   |
| Olsen-Hegar STILLE nålförare                     | 90   |
| Oretorp-STILLE sond                              | 206  |
| Osteotom STILLE                                  | 178  |
| Osteotom STILLE                                  | 178  |
| Osteotom STILLE                                  | 179  |
| Osteotom STILLE                                  | 179  |
| Overholt STILLE peang                            | 76   |

| Produktnamn  | Sida |
|--|------|
| <b>P</b>   |      |
| Palmer-STILLE benstift                               | 214  |
| Pean STILLE peang                                    | 66   |
| Peck-Joseph STILLE nässax                            | 43   |
| Peck-Joseph STILLE SuperCut XE nässax                | 43   |
| Perifer kärklämmare STILLE                           | 125  |
| Perman STILLE bukhake                                | 152  |
| Pincett STILLE                                       | 55   |
| Pincett STILLE                                       | 55   |
| Pincett STILLE                                       | 55   |
| Pincett STILLE                                       | 55   |
| Plattång STILLE                                      | 96   |
| Pryl STILLE  | 187  |
| <b>R</b>   |      |
| Ragnell Stille Diamond SuperCut dissektionssax       | 31   |
| Ragnell STILLE dissektionssax                        | 30   |
| Ragnell STILLE hake                                  | 147  |
| Ragnell STILLE operationssax                         | 35   |
| Ragnell STILLE raspatorium                           | 166  |
| Ragnell STILLE SuperCut XE dissektionssax            | 30   |
| Ragnell STILLE SuperCut XE ergonomisk dissektionssax | 32   |
| Ragnell STILLE SuperCut XE ergonomisk ögonlockssax   | 17   |
| Ragnell STILLE SuperCut XE ögonlockssax              | 17   |
| Ragnell Stille-Ekberg Diamond SuperCut               |      |
| ergonomisk dissektionssax                            | 31   |
| Ragnell Stille-Ekberg SuperCut                       |      |
| ergonomisk dissektionssax                            | 31   |
| Rapp-STILLE knuthållartång                           | 92   |
| Récamier STILLE uteruskyrett                         | 162  |
| Rees STILLE SuperCut XE Face-lift sax                | 48   |
| Rengöringsborste STILLE                              | 211  |
| Rochester-Ochsner STILLE peang                       | 71   |
| Rochester-Ochsner STILLE peang                       | 72   |
| Rochester-Péan STILLE peang                          | 70   |
| Rochester-Péan STILLE peang                          | 71   |
| Ruskin-STILLE gougetång                              | 102  |
| Russian STILLE pincett                               | 56   |
| Ryder STILLE nålförare                               | 88   |
| <b>S</b>   |      |
| Satinsky STILLE tangential occlusionsklämmare        | 124  |
| Sawtell STILLE peang                                 | 75   |
| Schnidt STILLE peang                                 | 74   |
| Schroeder STILLE klotång                             | 137  |
| Semb STILLE behållartång                             | 108  |
| Senn STILLE hake                                     | 148  |
| Sims STILLE dissektionssax                           | 22   |
| Skalpellhandtag STILLE                               | 209  |
| Skalpellhandtag STILLE                               | 209  |
| Slev STILLE  | 163  |
| Slev STILLE  | 163  |

| Produktnamn                                       | Sida |
|---|------|
| Sond STILLE                                       | 206  |
| Spencer STILLE sutursax                           | 50   |
| Spiraltång Stille-Norell                          | 134  |
| Spurling STILLE bittång                           | 114  |
| Stevens Stille-Ekberg Diamond SuperCut            |      |
| ergonomisk tenotomisax                            | 39   |
| Stevens Stille-Ekberg SuperCut                    |      |
| ergonomisk tenotomisax                            | 39   |
| Stevens-Stille Diamond SuperCut                   |      |
| ergonomisk tenotomisax                            | 38   |
| Stevens-Stille Diamond SuperCut tenotomisax       | 37   |
| Stevens-STILLE SuperCut tenotomisax               | 36   |
| Stevens-STILLE SuperCut XE ergonomisk tenotomisax | 38   |
| Stevens-STILLE tenotomisax                        | 36   |
| Stolte STILLE tonsillelevatorium                  | 172  |
| Strandell STILLE hake                             | 145  |
| Ståltrådshållare STILLE                           | 93   |
| Ståltrådsroterare STILLE                          | 93   |
| Sutursax STILLE                                   | 50   |
| <b>T</b>  |      |
| Thorek STILLE dissektionssax                      | 32   |
| Titan DeBakey STILLE mikropincett                 | 199  |
| Titan mikro ringpincett STILLE                    | 199  |
| Titan mikronålförare STILLE                       | 202  |
| Titan mikronålförare STILLE                       | 203  |
| Titan mikropincett STILLE                         | 198  |
| Titan mikropincett STILLE                         | 198  |
| Trådavbitare STILLE                               | 109  |
| Trådavbitare STILLE                               | 109  |
| Trådavbitare STILLE                               | 110  |
| Trådsåg STILLE-Gigli                              | 212  |
| <b>U</b>  |      |
| Universal STILLE ståltrådssax                     | 51   |
| Universalklämmare STILLE                          | 121  |
| Universalklämmare STILLE                          | 122  |
| Uppsala STILLE galltång                           | 119  |
| Uterusmanipulator STILLE                          | 138  |
| Uterussond STILLE                                 | 207  |
| Vienna STILLE nässpekulum                         | 158  |
| Volkman STILLE hake                               | 146  |

| Produktnamn                                 | Sida |
|---|------|
| <b>W</b>                                    |      |
| Waugh-Brophy STILLE anatomisk pincett       | 58   |
| Waugh-Brophy STILLE isolerad diatermpincett | 62   |
| Waugh-Brophy STILLE isolerad diatermpincett | 62   |
| Waugh-Brophy STILLE pincett                 | 56   |
| Webster STILLE nålförare                    | 83   |
| Webster STILLE nålförare                    | 84   |
| Webster/Kleinert STILLE nålförare           | 84   |
| Weitlaner STILLE hake                       | 155  |
| Wiberg STILLE raspatorium                   | 166  |
| Wiberg-STILLE benmärta                      | 215  |
| Wikström STILLE galltång                    | 119  |
| <b>Z</b>                                    |      |
| Zaufal-Jansen STILLE gougetång              | 101  |
| <b>Ö</b>                                    |      |
| Ögonlockssax ergonomisk STILLE SuperCut XE  | 17   |
| Ögonlockssax STILLE SuperCut XE             | 17   |
| Ögonsax STILLE                              | 16   |
| Ögonsax STILLE                              | 16   |
| Ögonsax STILLE SuperCut XE                  | 16   |

# Alphabetical index | Alphabetisches Inhaltsverzeichnis | Indice alfabetico | Índice alfabético | アルファベット索引

| Produktname   | Sida | Produktname                                 | Sida | Produktname  | Sida | Produktname  | Sida |
|---|------|---|------|--|------|--|------|
| <b>A</b>  |      | <b>A</b>                                    |      | <b>E</b>   |      | <b>J</b>   |      |
| Adlercreutz STILLE Tissue Forceps                                   | 56   | Boyd-STILLE Tonsil Scissors                 | 34   | Elevator STILLE  | 172  | Jabaley STILLE Dissecting Scissors                       | 18   |
| Adson STILLE Artery Forceps   | 73   | Breast Retractor STILLE                     | 150  | Ericsson-STILLE Carotid Clamp                          | 129  | Jabaley STILLE SuperCut XE Dissecting Scissors           | 19   |
| Adson STILLE Dressing Forceps                                       | 57   | <b>C</b>                                    |      | Ericsson-STILLE Profunda Femoral Artery Clamps         | 130  | Jabaley STILLE SuperCut XE Ergonomic Dissecting Scissors | 19   |
| Adson STILLE Self Retaining Retractor                               | 156  | Carlens STILLE Trachea Retractor            | 154  | Extraction plier STILLE                                | 97   | Jameson STILLE Caliper                                   | 208  |
| Adson STILLE Tissue Forceps   | 54   | Caspar STILLE Rongeur                       | 115  | Eye Scissors STILLE                                    | 16   | Joseph STILLE Nasal Scissors                             | 42   |
| Adson-Brown STILLE Tissue Forceps                                   | 54   | Castroviejo STILLE Caliper                  | 208  | Eye Scissors STILLE                                    | 16   | Joseph STILLE Raspatory                                  | 167  |
| Adson-Callison STILLE Tissue Forceps                                | 54   | Chisel STILLE                               | 185  | Eye Scissors STILLE SuperCut XE                        | 16   | Joseph STILLE Skin Hook                                  | 142  |
| Allis STILLE Intestinal Grasping Forceps                            | 133  | Christophe-STILLE Artery Forceps            | 68   |  |      | Joseph STILLE SuperCut XE Nasal Scissors                 | 42   |
| Allis STILLE Intestinal Grasping Forceps                            | 134  | Cinelli STILLE Osteotome                    | 183  | <b>F</b>   |      |  |      |
| Alm STILLE Retractor  | 155  | Cleaning Brush STILLE                       | 211  | Finochietto STILLE Rib Spreader                        | 157  | <b>K</b>   |      |
| Anastomosis Clamp STILLE  | 126  | Cobb STILLE Raspatory                       | 164  | Flap Retractor STILLE-Al Husseiny                      | 143  | Kaye STILLE Dissecting Scissors                          | 18   |
| Artery and Ligature Clamp STILLE                                    | 78   | Colon Clamp STILLE                          | 118  | Flat pliers STILLE                                     | 96   | Kaye STILLE Needle holder                                | 91   |
| Arthroscopy Cannula Set STILLE                                      | 213  | Converse STILLE Nasal Retractor             | 149  | Foerster STILLE Sponge Holding Forceps                 | 136  | Kaye STILLE SuperCut XE Dissecting Scissors              | 18   |
| Aston STILLE SuperCut XE Face-lift scissors                         | 47   | Converse STILLE Needle holder               | 91   | Fomon STILLE Nasal Scissors                            | 42   | Kelly STILLE Artery Forceps                              | 67   |
| Aufricht STILLE Nasal Retractor                                     | 148  | Cooper STILLE Operating Scissors            | 33   | Fomon STILLE Rasp                                      | 174  | Kelly-Rankin STILLE Artery Forceps                       | 68   |
| Awl STILLE  | 187  | Cottle STILLE Nasal Speculum                | 158  | Fomon STILLE SuperCut XE Nasal Scissors                | 44   | Kerrison STILLE Laminectomy Punch                        | 111  |
|   |      | Cottle STILLE Osteotome                     | 184  | Fracture Staple Wiberg-STILLE                          | 215  | Kerrison STILLE Laminectomy Punch                        | 112  |
| <b>B</b>  |      | Cottle STILLE Raspatory                     | 165  | Freer STILLE Elevator                                  | 169  | Kilner STILLE Needle holder                              | 83   |
| Babcock STILLE Intestinal Grasping Forceps                          | 132  | Cottle STILLE Septum Elevator               | 170  |  |      | Kirschner STILLE Wire Drill                              | 215  |
| Baby Mayo STILLE Dissecting Scissors                                | 21   | Cottle STILLE SuperCut XE Nasal Scissors    | 45   | <b>G</b>   |      | Kleinert-Kutz STILLE Skin Hook                           | 143  |
| Baby Metzenbaum STILLE Diamond SuperCut<br>Dissecting Scissors      | 23   | Crafoord STILLE Artery Forceps              | 77   | Gillies STILLE Needle Holder                           | 84   | Kocher STILLE Abdominal Spatula                          | 153  |
| Baby Metzenbaum STILLE Dissecting Scissors                          | 22   | Crafoord-STILLE Dressing Forceps            | 58   | Gillies STILLE Skin Hook                               | 142  | Kocher STILLE Artery Forceps                             | 67   |
| Baby Metzenbaum STILLE SuperCut XE<br>Dissecting Scissors           | 23   | Crile STILLE Artery Forceps                 | 69   | Gillies STILLE Tissue Forceps                          | 54   | König-STILLE Nail-splitting Scissors                     | 35   |
| Baby Metzenbaum STILLE SuperCut XE<br>Ergonomic Dissecting Scissors | 23   | Crile STILLE Artery Forceps                 | 69   | Gillquist-STILLE Arthroscopy Suction Tube              | 206  |  |      |
| Backhaus STILLE Towel Clamps  | 131  | Crile-Wood STILLE Delicate Needle holder    | 87   | Gorney STILLE SuperCut XE Ergonomic Face-lift scissors | 46   | <b>L</b>   |      |
| Barron STILLE Scalpel Handle  | 209  | Crile-Wood STILLE Needle holder             | 86   | Gorney STILLE SuperCut XE Face-lift scissors           | 46   | Lambert-Kay STILLE Aortic-Anastomosis Clamp              | 127  |
| Bengolea STILLE Artery Forceps                                      | 72   | Cushing STILLE Rongeur                      | 113  | Gouge STILLE   | 186  | Lambotte STILLE Mini Osteotome                           | 181  |
| Bergström-STILLE Muscle biopsy Cannula                              | 207  | <b>D</b>                                    |      | Gouge STILLE   | 186  | Lambotte STILLE Osteotome                                | 180  |
| Beyer STILLE Bone Rongeur   | 100  | Dandy STILLE Artery Forceps                 | 74   |  |      | Lambotte STILLE Osteotome                                | 180  |
| Beyer STILLE Bone Rongeur   | 101  | Davis STILLE SuperCut XE Face-lift Scissors | 47   | <b>H</b>   |      | Lambotte STILLE Raspatory                                | 165  |
| Björk-STILLE Diathermy Forceps                                      | 62   | De Bakey STILLE Vascular Forceps            | 61   | Halsey STILLE Needle Holder                            | 85   | Langenbeck STILLE Elevator                               | 170  |
| Björk-STILLE Knot-Holding Forceps                                   | 63   | De Bakey STILLE Vascular Forceps            | 61   | Halsted-Mosquito STILLE Artery Forceps                 | 66   | Langenbeck STILLE Retractor                              | 147  |
| Blepharoplasty Scissors STILLE SuperCut XE                          | 17   | De Bakey STILLE Vascular Forceps            | 61   | Halsted-Mosquito STILLE Artery Forceps                 | 66   | Leksell STILLE Bone Rongeur                              | 105  |
| Blepharoplasty Ergonomic Scissors STILLE SuperCut XE                | 17   | Deaver STILLE Retractor                     | 149  | Halsted-Mosquito STILLE delicate Artery Forceps        | 66   | Leksell STILLE Bone Rongeur                              | 106  |
| Bone curette STILLE   | 163  | DeBakey STILLE Aortic-Aneurysm Clamp        | 128  | Hand Osteotome STILLE                                  | 182  | Leriche STILLE Artery Forceps                            | 70   |
| Bone curette STILLE   | 163  | Derf STILLE Needle holder                   | 83   | Heiss STILLE Artery Forceps                            | 76   | Lexer STILLE Osteotome                                   | 182  |
| Bone Cutting Forceps STILLE   | 98   | Desmarres STILLE Eye-lid Retractor          | 150  | Hemostop STILLE  | 210  | Ligature Clamp STILLE-Ehrén                              | 78   |
| Bone Cutting Forceps STILLE   | 98   | Diamond Metzenbaum STILLE-Ekberg SuperCut   |      | Hohmann STILLE Elevator                                | 171  | Lister STILLE TC Bandage Scissors                        | 50   |
| Bone Cutting Forceps STILLE   | 99   | Ergonomic Dissecting Scissors               | 29   | Howarth STILLE Nasal Raspatory                         | 167  | Littauer STILLE Suture scissors                          | 51   |
| Bone Nail Palmer-STILLE   | 214  | Dissecting Scissors STILLE-Mayo             | 20   |  |      | Littler STILLE Suture carrying scissors                  | 49   |
| Bone Rongeur STILLE   | 102  | Dissecting Scissors STILLE-Mayo SuperCut XE | 21   | <b>I</b>   |      | Love STILLE Nerve Hook                                   | 144  |
| Bone Rongeur STILLE   | 104  | Dissector STILLE                            | 173  | Instrument Oil STILLE                                  | 211  | Love-Gruenwald STILLE Rongeur                            | 113  |
| Bone Rongeur STILLE   | 107  | Doyen STILLE Abdominal Retractor            | 151  | Instrument Sterilization Tray STILLE                   | 211  | Luer-STILLE Bone Rongeur                                 | 103  |
| Bone Wire STILLE  | 214  | Dressing Forceps STILLE                     | 57   | Iris Forceps STILLE                                    | 60   |  |      |
|   |      | Dressing Forceps STILLE                     | 57   | IUD Forceps STILLE-Norell                              | 134  |  |      |
|   |      | DUO-GRIP Needle holder STILLE-Frimand       | 87   |  |      |  |      |
|   |      | Duval STILLE Intestinal Grasping Forceps    | 132  |  |      |  |      |

| Produktnamn  | Sida |
|--|------|
| <b>M</b>   |      |
| Maier STILLE Sponge Holding Forceps  | 135  |
| Mallet STILLE  | 188  |
| Mallet STILLE  | 189  |
| Mallet STILLE  | 189  |
| Matarasso STILLE SuperCut XE Ergonomic Face-lift scissors                        | 48   |
| Matarasso STILLE SuperCut XE Face-lift scissors                                  | 48   |
| Mathieu STILLE Needle holder   | 90   |
| Mayo STILLE Dissecting Scissors  | 19   |
| Mayo STILLE Safety Pin   | 210  |
| Mayo STILLE SuperCut XE Dissecting Scissors                                      | 20   |
| Mayo-Harrington STILLE Operating Scissors  | 33   |
| Mayo-Harrington STILLE SuperCut XE Operating Scissors                            | 34   |
| Mayo-Hegar STILLE Heavy Needle holder  | 86   |
| Mayo-Hegar STILLE Needle holder  | 85   |
| Mayo-Noble STILLE Dissecting Scissors  | 21   |
| McIndoe STILLE Dressing Forceps  | 57   |
| Metzenbaum STILLE Delicate Diamond SuperCut Dissecting Scissors                  | 25   |
| Metzenbaum STILLE Delicate Dissecting Scissors                                   | 24   |
| Metzenbaum STILLE Delicate SuperCut XE Dissecting Scissors                       | 24   |
| Metzenbaum STILLE Diamond SuperCut Dissecting Scissors                           | 27   |
| Metzenbaum STILLE Dissecting Scissors  | 25   |
| Metzenbaum STILLE SuperCut XE Dissecting Scissors                                | 27   |
| Metzenbaum STILLE SuperCut XE Ergonomic Dissecting Scissors                      | 28   |
| Metzenbaum STILLE-Ekberg Delicate Diamond SuperCut Ergonomic Dissecting Scissors | 26   |
| Metzenbaum STILLE-Ekberg Delicate SuperCut Ergonomic Dissecting Scissors         | 26   |
| Metzenbaum STILLE-Ekberg SuperCut Ergonomic Dissecting Scissors                  | 28   |
| Micro DeBakey STILLE Forceps   | 197  |
| Micro DeBakey STILLE Forceps   | 197  |
| Micro Forceps STILLE   | 196  |
| Micro Forceps STILLE   | 196  |
| Micro Forceps STILLE   | 196  |
| Micro Needle Holder STILLE   | 200  |
| Micro Needle Holder STILLE   | 200  |
| Micro Needle Holder STILLE   | 200  |
| Micro Needle Holder STILLE   | 201  |
| Micro Needle Holder STILLE   | 201  |
| Micro Ring Forceps STILLE  | 197  |
| Micro Scissors STILLE SuperCut   | 194  |
| Micro Tissue Forceps STILLE  | 197  |
| Micro Vascular Scissors STILLE SuperCut  | 194  |
| Micro Vascular Scissors STILLE SuperCut  | 195  |
| Mini Multi-purpose clamp STILLE  | 120  |

| Produktnamn  | Sida |
|--|------|
| Mini Multi-purpose clamp STILLE                                      | 120  |
| Mini Tangential Occlusion Clamp STILLE                               | 123  |
| Mini-Hohmann STILLE Elevator   | 171  |
| Moberg STILLE Retractor  | 145  |
| Multi-purpose clamp STILLE   | 121  |
| Multi-purpose clamp STILLE   | 122  |
| <b>N</b>   |      |
| Nasal Elevator STILLE  | 169  |
| Nasal Raspatory STILLE   | 168  |
| Nasal Scissors STILLE SuperCut XE Needle holder STILLE               | 44   |
| Needle holder STILLE   | 89   |
| Needle holder STILLE   | 89   |
| Neivert STILLE Osteotome   | 183  |
| Nerve Hook STILLE  | 144  |
| New Orleans STILLE Needle holder                                     | 88   |
| <b>O</b>   |      |
| Olivecrona STILLE Artery Forceps                                     | 73   |
| Olivecrona STILLE Raspatory  | 164  |
| Olivecrona-STILLE Dura Forceps                                       | 59   |
| Olsen-Hegar STILLE Needle holder                                     | 90   |
| Oretorp-STILLE Probe   | 206  |
| Osteotome STILLE   | 178  |
| Osteotome STILLE   | 178  |
| Osteotome STILLE   | 179  |
| Osteotome STILLE   | 179  |
| Overholt STILLE Dissecting Forceps                                   | 76   |
| <b>P</b>   |      |
| Pean STILLE Artery Forceps   | 66   |
| Peck-Joseph STILLE Nasal Scissors                                    | 43   |
| Peck-Joseph STILLE SuperCut XE Nasal Scissors                        | 43   |
| Peripheral Vascular Clamp STILLE                                     | 125  |
| Perman STILLE Abdominal Retractor                                    | 152  |
| Plaster Cast Remover STILLE  | 213  |
| Probe STILLE   | 206  |
| <b>R</b>   |      |
| Ragnell STILLE Diamond SuperCut Dissecting Scissors                  | 31   |
| Ragnell STILLE Dissecting Scissors                                   | 30   |
| Ragnell STILLE Operating Scissors                                    | 35   |
| Ragnell STILLE Raspatory   | 166  |
| Ragnell STILLE Retractor   | 147  |
| Ragnell STILLE SuperCut XE Blepharoplasty Scissors                   | 17   |
| Ragnell STILLE SuperCut XE Dissecting Scissors                       | 30   |
| Ragnell STILLE SuperCut XE Ergonomic Blepharoplasty Scissors         | 17   |
| Ragnell STILLE SuperCut XE Ergonomic Dissecting Scissors             | 32   |
| Ragnell STILLE-Ekberg Diamond SuperCut Ergonomic Dissecting Scissors | 31   |

| Produktnamn  | Sida |
|--|------|
| Ragnell STILLE-Ekberg SuperCut Ergonomic Dissecting Scissors       | 31   |
| Rapp-STILLE Knot-holding Forceps                                   | 92   |
| Récamier STILLE Uterine curette                                    | 162  |
| Rees STILLE SuperCut XE Face-lift scissors                         | 48   |
| Retractor STILLE   | 146  |
| Rochester-Ochsner STILLE Artery Forceps                            | 71   |
| Rochester-Ochsner STILLE Artery Forceps                            | 72   |
| Rochester-Péan STILLE Artery Forceps                               | 70   |
| Rochester-Péan STILLE Artery Forceps                               | 71   |
| Ruler STILLE   | 208  |
| Ruskin-STILLE Bone Rongeur   | 102  |
| Russian STILLE Tissue Forceps                                      | 56   |
| Ryder STILLE Needle holder   | 88   |
| <b>S</b>   |      |
| Satinsky STILLE Tangential Occlusion Clamp                         | 124  |
| Sawtell STILLE Artery Forceps                                      | 75   |
| Scalpel Handle STILLE  | 209  |
| Scalpel Handle STILLE  | 209  |
| Schmidt STILLE Artery Forceps                                      | 74   |
| Schroeder STILLE Tenaculum Forceps                                 | 137  |
| Semb STILLE Bone Holding Forceps                                   | 108  |
| Senn STILLE Retractor  | 148  |
| Sims STILLE Dissecting Scissors                                    | 22   |
| Spencer STILLE Suture scissors                                     | 50   |
| Spurling STILLE Rongeur  | 114  |
| Stevens STILLE-Ekberg Diamond Ergonomic SuperCut Tenotomy Scissors | 39   |
| Stevens STILLE-Ekberg Ergonomic SuperCut Tenotomy Scissors         | 39   |
| Stevens-STILLE Diamond Ergonomic SuperCut Tenotomy Scissors        | 38   |
| Stevens-STILLE Diamond SuperCut Tenotomy Scissors                  | 37   |
| Stevens-STILLE SuperCut Tenotomy Scissors                          | 36   |
| Stevens-STILLE SuperCut XE Ergonomic Tenotomy Scissors             | 38   |
| Stevens-STILLE Tenotomy Scissors                                   | 36   |
| Stolte STILLE Tonsil Elevator                                      | 172  |
| Strandell STILLE Retractor   | 145  |
| Suture scissors STILLE   | 50   |
| <b>T</b>   |      |
| Thorek STILLE Dissecting Scissors                                  | 32   |
| Tissue Forceps STILLE  | 55   |
| Tissue Forceps STILLE  | 55   |
| Tissue Forceps STILLE  | 55   |
| Tissue Forceps STILLE  | 55   |
| Titanium Micro DeBakey STILLE Forceps                              | 199  |
| Titanium Micro Forceps STILLE                                      | 198  |
| Titanium Micro Forceps STILLE                                      | 198  |
| Titanium Micro Needle Holder STILLE                                | 202  |

| Produktnamn                                     | Sida |
|---|------|
| Titanium Micro Needle Holder STILLE             | 203  |
| Titanium Micro Ring Forceps STILLE              | 199  |
| <b>U</b>  |      |
| Universal STILLE Wire Cutting scissors          | 51   |
| Uppsala STILLE Gall Duct Clamp                  | 119  |
| Uterine Manipulator STILLE                      | 138  |
| Uterine Sound STILLE                            | 207  |
| <b>V</b>  |      |
| Vascular Scissors STILLE-Lund                   | 41   |
| Vascular Scissors STILLE SuperCut XE            | 40   |
| Vascular Scissors STILLE SuperCut XE            | 40   |
| Vienna STILLE Nasal Speculum                    | 158  |
| Volkman STILLE Retractor                        | 146  |
| <b>W</b>  |      |
| Waugh-Brophy STILLE Dressing Forceps            | 58   |
| Waugh-Brophy STILLE insulated Diathermy Forceps | 62   |
| Waugh-Brophy STILLE insulated Diathermy Forceps | 62   |
| Waugh-Brophy STILLE Tissue Forceps              | 56   |
| Webster STILLE Needle holder                    | 83   |
| Webster STILLE Needle holder                    | 84   |
| Webster/Kleinert STILLE Needle holder           | 84   |
| Weitlaner STILLE Retractor                      | 155  |
| Wiberg STILLE Raspatory                         | 166  |
| Wikström STILLE Gall Duct Clamp                 | 119  |
| Wire Cutter STILLE                              | 109  |
| Wire Cutter STILLE                              | 109  |
| Wire Cutter STILLE                              | 110  |
| Wire Holding Forceps STILLE                     | 93   |
| Wire Saw STILLE-Gigli                           | 212  |
| Wire Twisting Forceps STILLE                    | 93   |
| <b>Z</b>  |      |
| Zaufal-Jansen STILLE Bone Rongeur               | 101  |



# Garanti | Guarantee | Garantie | Garanzia | Garantie

## Hanteringsanvisningar

Följande råd och skötselansvisningar har framtagits för att ni skall få största möjliga nytta och glädje av samt optimal livslängd på kirurgiska instrument från STILLE. Dessutom är villkoret för STILLES garantiåtgående att instrumentet hanteras och sköts i enlighet med nedan angivna instruktioner.

1. Hantera instrument varsamt, detta gäller instrument i allmänhet och mikroinstrument i synnerhet. Ytbehandlade instrument (STILLE Diamond) kan vara extra känsliga i samband med diatermi. Undvik direkt kontakt med diatermi-elektrod då detta kan medföra skador på ytskiktet.
2. Rengör instrumentet manuellt eller maskinellt så fort som möjligt efter användning. Låt ej föroreningar torka in på instrumentet. Rengöring med metoder som innehåller väteperoxid rekommenderas ej på instrument med svartkrom. Dessa kan bli flammiga, dock påverkas inte funktionen.
3. Förvara inte instrument i fuktig miljö längre än absolut nödvändigt, t.ex. i avvaktan på transport till sterilcentral. Använd endast för ändamålet avsedda lösningar.
4. Låt inte instrument ligga i mekanisk spänning, t.ex. knäppta eller intrasslade i andra instrument. Det föreligger då risk för spänningskorrosion. Instrument med knäppen skall lämnas öppna. Lägg de tyngsta instrumenten underst med de lättare ovanpå. Mikrokirurgiska instrument skall aldrig läggas ovanpå varandra.
5. Vatten och vattenånga för rengöring, desinfektion och autoklavering kan innehålla salter, metaller och mineraler, vilka kan orsaka korrosion och missfärgningar. Kontrollera vattenkvaliteten. Hårt vatten bör mjukgöras. Slutsköljning av instrument med demineraliserat vatten rekommenderas.
6. Följ alltid fabrikantens anvisningar vid användning av diskdesinfektor och diskmedel. Använd ett diskmedel med pH-värde mellan 8-10,5 i korrekt dosering enligt tillverkarens anvisningar. Förvara inte instrumentet under längre tid i lösningen än vad fabrikanter angivit. Skölj, helst med demineraliserat vatten. Torka instrumentet omedelbart. Följ standard EN-ISO 15883 samt nationella riktlinjer – använd endast validerad process för rengöring och desinfektion.
7. Använd endast för ändamålet avsedda desinfektionslösningar vid manuell rengöring. Var noga med att följa fabrikantens anvisningar vad gäller dosering och tid. Förvara inte instrumentet under längre tid i lösningen än vad fabrikanter angivit. Skölj, helst med demineraliserat vatten. Torka instrumentet omedelbart.
8. Vid användning av ultraljud för rengöring skall instrumentet vara helt täckt med vätska samt vara öppet. Instrument med ytbeläggning skall ej rengöras i ultraljud. Skölj, gärna med demineraliserat vatten. Torka noga. Följ fabrikantens anvisningar.
9. Kontrollera instrument med avseende på föroreningar, repor, missfärgningar, sprickor, korrosion.
10. Kontrollera varje enskilt instruments funktion.
11. Använd endast instrumentborstar. Stålull får aldrig användas.
12. Anolj instrument, på ställen där metall nöter mot metall, efter varje användning. Anoljning görs lämpligen omedelbart före sterilisering. Använd gärna STILLES instrumentolja. Oljan måste ha en flampunkt över 135°C. Använd endast ringa mängd olja på ytor som möts vid funktion (saxskär, boxlås, skruvar, spärrlås). Torka bort överflödiga olja för undvikande av kladdiga instrument samt fettfläckar på autoklaveringsförpackningen.

13. Följ noga fabrikantens anvisningar vid autoklavering. Var noga med att inte packa instrumenten hårt. Instrument skall autoklaveras "öppna" för att ångan skall kunna nå alla delar av ett instrument.
14. Hetluftssterilisering rekommenderas ej. Hög temperatur påverkar metall-len.
15. Väteperoxidsterilisering rekommenderas ej för svartkromade instrument. Dessa kan bli flammiga, dock påverkas inte funktionen.
16. Nya instrument måste rengöras, inspekteras, anoljas samt steriliseras före första användning.
17. Använd endast professionell reparatör/verkstad för service och reparationer. T.ex. måste Super Cut -saxar slipas på ett speciellt sätt, annars är det lätt att förstöra eggen. Vid felaktigt utförd reparation/ service gäller ej STILLES garantiåtgående!

## Garanti

Med avseende på utförande och material lämnar vi garanti på kirurgiska handinstrument av egen tillverkning. I en period av 30 år efter inköp, ersätter eller reparerar vi kostnadsfritt ett skadat instrument om skadan finnes orsakad av fel i utförande eller material. Normal förslitning omfattas inte av vår garanti. Utfästelsen gäller under förutsättning att att instrumentet används för avsett ändamål samt vårdas och lagras korrekt och att skriftlig anmälan görs till STILLE inom 30 dagar från skadetillfället.

## Instrument Care

The following advice and care instructions have been drawn up to achieve the maximum utilization and optimal length of life from STILLE's surgical instruments. In addition, one of the conditions of STILLE's guarantee commitments is that instruments are handled and cared for according to the instructions stated below.

1. Handle instruments carefully. This applies to instruments in general but particularly to micro instruments. Coated STILLE Diamond instruments may be sensitive for diathermy. Avoid direct contact with diathermy electrode as this may cause damages to the surface coating.
2. Clean instruments manually or by machine as soon as possible after use. Do not allow contaminants to dry on instruments. Cleaning with any method containing hydrogen peroxide is not recommended for black chrome plated instruments (eg SuperCut scissors).
3. If cleaning must be delayed, store the instruments in an appropriate solution. Do not just use water.
4. Do not allow instruments to remain under mechanical stress since this increases the risks for corrosion and damage. Instruments must not be allowed to lie in a disorganized manner. Instruments with ratchets must be left open. The heaviest instruments on the bottom with lighter instruments above. Microsurgical instruments should never be laid on top of each other.

5. Water and steam used for cleaning, disinfection and auto-claving may contain salts, metals and minerals that can cause corrosion and discoloration. Check the quality of the water; hard water should be softened. Final rinsing of instruments with demineralized water is recommended.
6. Always follow the manufacturer's instructions when using disinfectants and detergents. Use a detergent with a pH-value between 8-10,5 in correct dosage according to the manufacturer's instructions. Do not store the instrument in the solution longer than indicated by the manufacturer. Rinse, preferably with demineralized water. Dry the instrument immediately. Follow standard EN-ISO 15883 and national guidelines – only use validated machine cleaning and disinfection processes.
7. Only use disinfection solutions intended for this purpose. Follow the manufacturer's instructions. Rinse, ideally with demineralized water. Dry the instruments.
8. When using ultrasound for cleaning, instruments should be opened and completely covered with cleaning solution. Coated instruments should not be cleaned in ultrasound. Rinse, ideally with demineralized water. Dry carefully. Follow the manufacturer's instructions.
9. Check instruments for contaminants, scratches, discoloration, cracks and corrosion.
10. Check the function of each individual instrument.
11. Use only instrument brushes. Steel wool should never be used.
12. After the cleaning process, lubricate the instruments where metal is in contact with metal. Use preferably STILLE instrument oil. The oil must have a flashpoint above 135 °C. Use only small amounts of oil on surfaces that are in contact during function (scissors edges, box locks, screws). Clean off excess oil to avoid oily instruments and oily stains on autoclave packaging. If a water-soluble lubricant is used instead of instrument oil, the solution should be diluted with demineralized water. Follow the manufacturer's instructions.
13. Follow the manufacturer's instructions for autoclaving. Instruments should be autoclaved open to allow steam to gain access to all parts of the instruments.
14. Hot air sterilisation is not recommended, as high temperature will affect the metal.
15. Hydrogen peroxide sterilisation is not recommended for black chrome plated instruments. These can become stained although function will not be affected.
16. New instruments must be cleaned, inspected, lubricated and sterilised before they are used for the first time.
17. Use only a professional instrument engineer/workshop for service and repairs. For example, Super Cut scissors must be ground in a special way otherwise the edges may be destroyed. If repairs/service are incorrectly carried out, STILLE's guarantee commitments no longer apply!

## Guarantee

Surgical hand instruments manufactured by STILLE carry a guarantee in respect of materials and workmanship. For a period of 30 years after purchase, we will replace or repair a damaged instrument free of charge if the damage is found to have been caused by a defect in materials or workmanship. The guarantee is conditional on the instrument being used for the purpose intended, is cared for and stored correctly and that any claims are made in writing within 30 days of the damage occurring.

## Gebrauchsanweisungen

Die folgenden Ratschläge und Gebrauchsanleitungen haben wir für Sie gemacht, damit Sie den grösstmöglichen Nutzen und Freude, sowie eine optimale Lebensdauer an chirurgische Instrumente von STILLE haben werden. Unsere Garantie ist auch mit der Bedingung verbunden, dass unsere Instrumente nach unseren Instruktionen behandelt und gepflegt werden.

1. Gebrauchen Sie die Instrumente mit Vorsicht, ganz besonders die Mikroinstrumente. Die beschichteten STILLE Diamond Instrumente können empfindlich bei der Anwendung von HF-Chirurgie reagieren. Vermeiden Sie den direkten Kontakt mit der Diathermie-Elektrode, da die Oberflächenbeschichtung der Instrumente beschädigt werden könnte.
2. Beseitigen Sie den Schmutz, manuell oder maschinell, direkt nach Gebrauch. Lassen Sie den Schmutz nie in das Instrument eintrocknen. Für schwarz verchromte Instrumente (z. B. SuperCut-Scheren) wird eine Reinigung mit Wasserstoffperoxid nicht empfohlen.
3. Lassen Sie die Instrumente nie länger als notwendig in feuchten Zustand liegen, z.B. beim Abwarten auf Transport zur Sterilzentrale. Benützen Sie nur die für das Instrument bestimmten Desinfektionsmittel.
4. Lassen Sie die Instrumente nicht in mechanischer Spannung, z.B. zusammengespannt oder mit anderen Instrumenten durcheinander liegen. Es kann sonst zu Spannungskorrosion kommen. Legen Sie die schwersten Instrumente nach unten und die leichteren oben drauf. Mikrochirurgische Instrumente dürfen niemals aufeinander liegen.
5. Wasser und Wasserdampf für Reinigung, Desinfektion und Sterilisierung können Salze, Metalle und Minerale enthalten die Korrosion und Verfärbungen verursachen können. Kontrollieren Sie die Wasserqualität. Hartes Wasser muss enthärtet werden. Für die Schlusspülung des Instrumentes empfehlen wir demineralisiertes Wasser.
6. Folgen Sie immer den Anweisungen des Herstellers bei Verwendung von Desinfektions- und Reinigungsautomaten, sowie beim Spülmittel. Verwenden Sie ein Reinigungsmittel mit einem pH-Wert von 8 - 10,5. Dosierungsangaben des Herstellers beachten! Die Instrumente dürfen nicht länger als vom Hersteller angegeben in der Lösung liegen. Das Spülen sollte mit vollentsalztem Wasser erfolgen. Trocknen Sie das Instrument sofort. Richten Sie sich nach dem EN-ISO 15883 Standard und den nationalen Vorschriften - verwenden Sie nur validierte maschinelle Reinigungs- und Desinfektionsverfahren.
7. Benützen Sie nur die für das Instrument vorgeschriebene Desinfektionslösung bei manueller Reinigung. Richten Sie nach den Anweisungen des Herstellers wegen Dosierung und Zeit. Die Instrumente dürfen nicht länger als vom Hersteller angegeben in der Lösung liegen. Spülen Sie am besten mit demineralisiertem Wasser. Trocknen Sie das Instrument hinterher.
8. Bei Ultraschallbehandlung muss das Instrument ganz in der Lösung und offen liegen. Beschichtete Instrumente dürfen nicht mit Ultraschall gereinigt werden. Spülen Sie mit demineralisiertem Wasser nach. Seien Sie sorgfältig beim Trocknen. Befolgen Sie die Anweisungen des Herstellers.
9. Kontrollieren Sie das Instrument auf Schmutz, Risse, Verfärbungen, Brüche und Korrosion.
10. Kontrollieren Sie jede einzelne Funktion des Instrumentes.
11. Bei der Reinigung verwenden Sie nur besondere für Instrumente geeignete Bürsten. Stahlwolle darf nie gebraucht werden. Es kann sonst zu Rissen und Eisenspänen auf dem Instrument kommen, was zur Korrosion führen kann.
12. Ölen Sie das Instrument leicht ein an Stellen, wo sich das Metall trifft (z.B. Scherenblätter, Box-Schlösser, Schrauben, Rasten) nach jedem Gebrauch. Die Einölung wird am besten vor der Sterilisierung vorgenommen. Wir empfehlen die Verwendung von Instrumentenöl von STILLE. Das Öl muss einen Entflammbarkeitsgrad von über 135 Grad Celsius haben. Trocknen Sie überflüssiges Öl auf, um schmierige Instrumente und Fettflecke auf den Steril-Verpackungen zu vermeiden.

13. Folgen Sie den Anweisungen des Herstellers sehr genau bei der Sterilisierung. Es ist wichtig das man die Instrumente nicht zu hart packt. Die Instrumente sollen in offenem Zustand sterilisiert werden, damit der Dampf an alle Teile des Instrumentes kommt.
14. Wir empfehlen keine Heissluftsterilisierung. Die hohen Temperaturen schaden dem Metall.
15. H<sub>2</sub>O<sub>2</sub> Sterilisierung empfehlen wir nicht für schwarzverchromte Instrumente. Sie können flammig werden. Die Funktion wird dagegen nicht beeinträchtigt.
16. Neue Instrumente müssen gereinigt, kontrolliert, eingölt und sterilisiert werden vor dem ersten Gebrauch.
17. Für Service und Reparaturen machen Sie nur von professionellen Reparateuren/Werkstätten Gebrauch. Z.B. müssen Super Cut-Scheren speziell geschliffen werden, damit die Schneide nicht zerstört wird. Bei falsch ausgeführter Reparatur/Service gilt nicht die STILLE-Garantie.

## Garantie

Wir übernehmen, auf Ausführung und Material von chirurgischen Instrumenten eigener Herstellung eine Garantie von 30 Jahren d.h., wir ersetzen oder reparieren kostenlos beschädigte Instrumente, bei denen die Ausführung oder das Material fehlerhaft ist. Diese Garantie erstreckt sich nicht auf den normalen Verschleiss. Die Garantieverpflichtung ist gültig unter der Voraussetzung, dass die Instrumente für vorgesehenen Zweck verwendet und fachgemäss gepflegt werden, sowie dass eingetretener Schaden uns innerhalb von 30 Tagen schriftlich mitgeteilt wird.

## Trattamento degli strumenti chirurgici

I seguenti consigli e prescrizioni permettono di ottenere le migliori prestazioni e una lunga durata degli strumenti chirurgici STILLE. La garanzia STILLE è valida solo se vengono rispettate le istruzioni indicate.

1. Trattare tutti gli strumenti chirurgici con cura, in particolare gli strumenti per microchirurgia.
2. Pulire lo strumento immediatamente dopo l'utilizzo, a mano o meccanicamente. Non permettere alle impurità di indurire sugli strumenti. Non utilizzare prodotti contenenti perossido di idrogeno per la pulizia di strumenti con cromatura nera (ad esempio forbici SuperCut).
3. Non lasciare gli strumenti in ambiente umido più di quanto sia necessario, ad es. in attesa di essere trasportati al centro di sterilizzazione. Usare soluzioni appropriate, non acqua.
4. Per evitare il rischio di corrosione per tensione, non sottoporre lo strumento a tensione meccanica: in stato chiuso o intricato con altri strumenti. Strumenti a cremagliera devono rimanere aperti. Posare gli strumenti leggeri sopra quelli più pesanti. Gli strumenti per microchirurgia vanno sistemati uno vicino a l'altro.
5. Acqua e vapore utilizzato per la pulitura, la disinfezione e nell'autoclave possono contenere sali, metalli e minerali, i quali possono provocare corrosione e colorazioni. Verificare le caratteristiche dell'acqua. L'acqua che contiene una concentrazione troppo elevata di sali e di cloro deve essere filtrata e trattata. Si consiglia l'uso di acqua demineralizzata, soprattutto per la risciacquatura finale.

6. All'uso di prodotti per la disinfezione e la pulitura rispettare sempre le prescrizioni del produttore. Utilizzare un detergente con pH 8-10,5, dosaggio secondo le istruzioni del produttore. Non lasciare lo strumento nella soluzione più a lungo di quanto indicato dal fabbricante. Risciacquare, preferibilmente utilizzando acqua demineralizzata. Asciugare immediatamente.
7. Per la pulitura manuale usare unicamente soluzioni disinfettanti prescritte. Seguire attentamente le istruzioni per quanto riguarda la dose e la durata. Non lasciare gli strumenti nella soluzione più a lungo di quanto prescritto. Sciacquare con acqua demineralizzata e asciugare immediatamente.
8. Per la pulitura ad ultrasuoni lo strumento deve essere aperto e completamente immerso nella soluzione. Gli strumenti rivestiti non devono essere puliti ad ultrasuoni. Risciacquare con acqua demineralizzata e provvedere ad un'asciugatura completa e immediata.
9. Controllare che non ci siano residui, scalfitture, scolorimenti, fessure o macchie di corrosione sullo strumento.
10. Controllare il funzionamento di ogni strumento individualmente.
11. Usare unicamente spazzole morbide per strumenti - mai spugne o spazzole metalliche
12. Lubrificare lo strumento dopo ogni uso, nei punti di contatto tra le parti metalliche, immediatamente prima della sterilizzazione. Si consiglia olio STILLE per strumenti. In ogni caso si deve usare olio con punto d'infiammabilità superiore a 135 ° C. È sufficiente una goccia sulle superficie a contatto (filo delle forbici, cerniere ad incastro, fermagli, vite e tacche d'arresto). Rimuovere l'olio eccessivo per evitare strumenti grassi e macchie sul materiale d'imballaggio per l'autoclave.
13. Rispettare scrupolosamente le prescrizioni del costruttore degli sterilizzatori. Non imballare troppo forte. Gli strumenti devono essere aperti durante la sterilizzazione, permettendo al vapore di raggiungere tutte le parti dello strumento.
14. Sconsigliamo sterilizzazione a secco. Temperature alte possono alterare la struttura del metallo.
15. La sterilizzazione con acqua ossigenata non è consigliabile per strumenti cromati di nero. Detta procedura non compromette la funzione, ma le superficie nere si scoloriscono.
16. Strumenti nuovi devono essere puliti, controllati, oliati e sterilizzati prima del primo uso.
17. Riparazioni e manutenzione devono essere eseguite da professionali. Per esempio le forbici Super Cut (una lama da forbice e una lama da coltello) devono essere affilate in modo speciale per non rovinare il filo. La garanzia STILLE non è valida per riparazioni effettuate in modo errone.

## Garanzia

Lo strumentario chirurgico della nostra propria produzione è coperto da una garanzia di 30 (Trenta) anni contro qualsiasi difetto di fabbricazione o di qualità del materiale usato. Ci impegniamo a ripararlo o a rimpiazzarlo a nostre spese, sempre se è un difetto di produzione o di materiale. La garanzia non copre il logoramento normale, neppure difetti dovuti a mancata manutenzione. Questo impegno è valevole a condizione che gli strumenti siano usati per lo scopo previsto e che siano custoditi e mantenuti in modo professionale, e che il reclamo per iscritto ci pervenga entro 30 giorni a partire dalla data di constatazione del guasto.

## Tratamiento del instrumental quirúrgico

Hemos desarrollado los siguientes consejos e instrucciones de mantenimiento para que Ud. obtenga el mayor rendimiento y duración de los instrumentos quirúrgicos de STILLE. Asimismo, el compromiso de garantía de STILLE sólo es válido si el instrumento se utiliza y cuida según las instrucciones indicadas a continuación.

1. Trate el instrumento con cuidado. Este punto es aplicable a todos los instrumentos en general y a los microinstrumentos en particular. Los Instrumentos STILLE Diamond revestidos pueden ser sensibles a la diatermia. Evite el contacto directo con el electrodo de diatermia ya que esto puede causar daños en el revestimiento de la superficie.
2. Limpie el instrumento, a mano o a máquina, tan pronto como sea posible tras su utilización. No deje secar partículas extrañas en el instrumento. No se recomienda ningún método de limpieza que contenga hidrógeno de peróxido para instrumentos de cromadura negra (ej: Tijeras SuperCut).
3. No conserve el instrumento en un ambiente húmedo más tiempo del necesario, por ej. mientras espera su transporte a la central de esterilización. Utilice únicamente los métodos adecuados para cada caso.
4. No deje los instrumentos en tensión, por ej. cerrados o enredados con otros instrumentos. En estos casos aumenta el riesgo de corrosión. Los instrumentos con cierre deben dejarse abiertos. Coloque los instrumentos más pesados debajo y los más ligeros encima. No coloque nunca los instrumentos microquirúrgicos unos encima de otros.
5. El agua y vapor de agua para la limpieza, desinfección y esterilización con autoclave pueden contener sales, metales y minerales que pueden provocar corrosión y manchas. Controle la calidad del agua. El agua dura debe ablandarse. Se recomienda el enjuague final del instrumento con agua desmineralizada.
6. Siga siempre las instrucciones del fabricante al usar productos desinfectantes y de limpieza. Utilice un detergente con un pH comprendido entre 8-10.5 a una dosis correcta según las instrucciones del fabricante. No almacene el instrumento en la solución por un tiempo mayor al indicado por el fabricante. Remoje, preferiblemente con agua desmineralizada. Seque el instrumento inmediatamente. Siga la norma EN-ISO 15883 y las directrices nacionales - sólo utilizar los procesos válidos de limpieza y desinfección.
7. Al limpiar a mano, utilice únicamente soluciones desinfectantes adecuadas. Siga las instrucciones del fabricante en lo que respecta a dosificación y tiempo. No tenga el instrumento en la solución más tiempo del indicado por el fabricante. Enjuáguelo, preferentemente con agua desmineralizada. Seque el instrumento inmediatamente.
8. En caso de utilizar ultrasonido para la limpieza del instrumento, éste debe estar abierto y completamente cubierto con la solución de limpieza. Instrumentos con revestimiento no deben ser limpiados con ultrasonido (ej: instrumentos con niquelado). Enjuáguelo, preferentemente con agua desmineralizada. Séquelo cuidadosamente. Siga las instrucciones del fabricante.
9. Controle el instrumento para evitar la aparición de suciedad, rayas, manchas, estrías y corrosión.
10. Controle la función de cada instrumento por separado.
11. Utilice únicamente cepillos para instrumentos. No utilice nunca estropajos de acero.
12. Después de cada uso, ponga aceite en el instrumento en los lugares en los que el metal esté en contacto con metal. El mejor momento para poner aceite es justo antes de la esterilización. Utilice preferentemente el aceite para instrumentos de STILLE. El aceite debe tener un punto de inflamación por encima de 1350C. Utilice el aceite con moderación en superficies que entran en contacto durante el uso (hojas, cierres y tornillos). Quite el aceite sobrante para evitar tener instrumentos grasientos y la aparición de manchas de grasa en el envase de esterilización con autoclave.
13. Siga las instrucciones del fabricante en la esterilización con autoclave. No coloque demasiados instrumentos a la vez. Durante la esterilización con autoclave, los instrumentos deben estar "abiertos" para que el vapor llegue a todos los rincones de cada instrumento.
14. No se recomienda la esterilización con aire caliente. Las elevadas temperaturas repercuten en el metal.
15. No se recomienda la esterilización con peróxido de hidrógeno para instrumentos de cromo negro. El color de estos instrumentos puede cambiar, aunque su funcionalidad no se vea afectada.
16. Antes de su primera utilización, limpie, controle, ponga aceite y esterilice todos los instrumentos nuevos.
17. Utilice únicamente un especialista/taller profesional para servicio y reparaciones. Por ej. las tijeras de Super Cut deben afilarse de modo especial, en caso contrario es fácil destruir la parte cortante. Si una reparación/servicio se realiza de modo incorrecto, la garantía de STILLE no es válida.

## Garantie

El instrumental quirúrgico de nuestra propia fabricación tiene una garantía de 30 (Treinta) años contra cualquier defecto de manufacturación o calidad del material empleado, obligándonos a reemplazarlo o repararlo sin cargo alguno, siempre que sea debido a defectos del material o de su fabricación. El desgaste normal por su uso, queda excluido de dicha garantía. Esta garantía queda condicionada a que el instrumental sea utilizado para la finalidad prevista siendo cuidado y conservado de acuerdo con nuestras instrucciones y debiendo comunicar su deterioro por escrito dentro de los 30 días a partir del mismo.







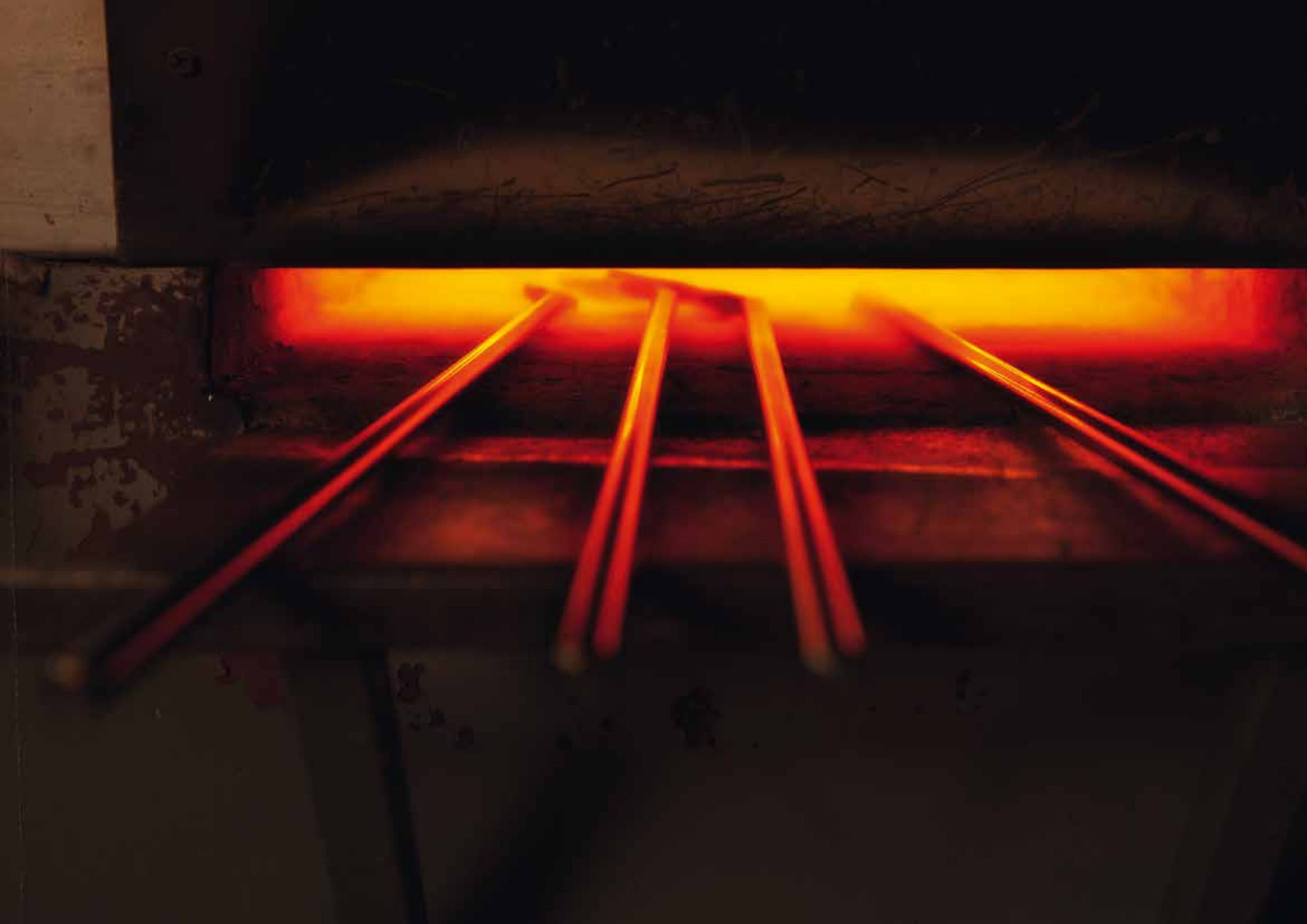

**DR. LARS LEKSELL**, professor i neurokirurgi vid Lunds universitet och Karolinska institutet, kirurg vid Serafimerlasarettet och Sundsvalls lasarett samt ledamot av Kungliga Vetenskapsakademien. Uppfann strålkniven Leksell Gamma Knife 1951. Utvecklade tillsammans med STILLE den mycket populära gougetången som bär namnet STILLE-Leksell.

**DR. LARS LEKSELL**, professor of neurosurgery at Lund University and the Karolinska Institute, surgeon at the Serafimer Hospital and Sundsvall Hospital and a member of the Royal Swedish Academy of Sciences. Inventor of the Leksell Gamma Knife in 1951. Developed in collaboration with STILLE the very popular gouge forceps bearing the name STILLE-Leksell.





## **STILLE Surgical Instruments**

Edition 3.1, June 2018

Photos: Åke Gunnarsson, Vue and Jonas Frid, Studio Roland

Printing: Arkitektkopia AB

Paper on cover: Invercote Creato Matt 300 g. Paper, inlet: Galerie Art Gloss 130 g

Printed in Sweden 2018. Article number: 950-01-04

© STILLE AB 2018



“Det var ett intensivt arbetsamt liv, som Albert Stille kunde blicka tillbaka på när han 1880 lämnade över den tekniska ledningen av sin firma till sonen Max. Från morgon till kväll var han på verkstaden och på kontoret, knappast unnande sig någon ro ens under måltiderna. Arbetet följdes av stor framgång tack vare hans gedigna kunskaper, hans utomordentliga skicklighet i yrket och hans konstnärssinne. När det gällde att finna på nya metoder och nya instrument svek aldrig hans intresse, och han lät sig ej avskräckas av någon svårighet.”

Ur “STILLE 1841-1941 – Återblick på en hundraårig verksamhet”

“It was a hectic working life that Albert Stille looked back on in 1880 when he handed over the technical management of the company to his son Max. From morning to night he was at the shop and in the office, scarcely allowing himself to rest even at mealtime. The work was followed by great success due to his extensive knowledge, his outstanding skill in the profession and his inventive mind. When it came to finding new methods and new instruments his interest remained strong, and he allowed himself not to be discouraged by any difficulty that arose.”

From “STILLE 1841-1941 - Flashback on a century of operation”

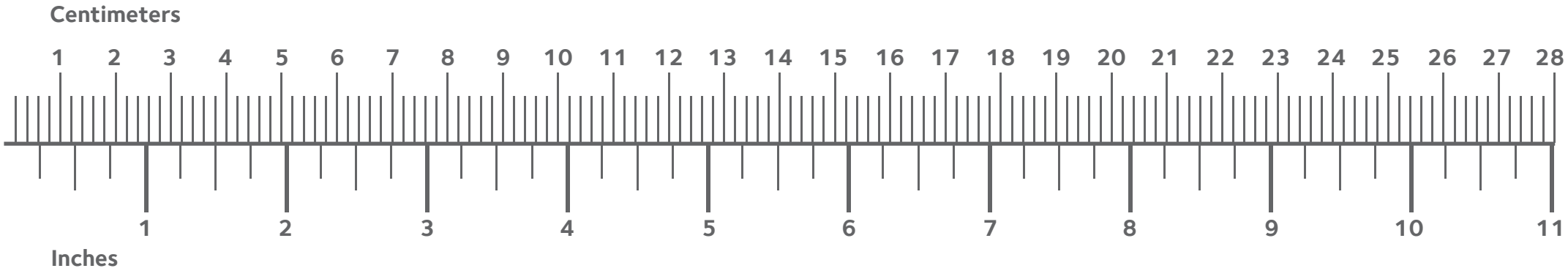



**HANTVERK HELA VÄGEN.** Att skapa kvalitetsinstrument är ett hantverk hela vägen – från instrumentmakaren till kirurgen. Passionen, yrkesskickligheten och fingertoppskänslan har de gemensamt. Och genom deras nära samarbete vidareutvecklas instrumenten. Sortimentet är specialiserat på tre områden – plastikkirurgi, ortopedi samt klassiska STILLE-instrument för flera olika kirurgiska discipliner. Gediget hantverk, suverän funktion och överlägsen kvalitet är de unika instrumentegenskaper som gör att STILLE efterfrågas av kirurger över hela världen.



**CRAFTSMANSHIP ALL THE WAY.** Creating quality instruments is an art form every step of the way – from the instrument maker to the surgeon. Passion, professionalism and flair are common attributes. And through their close collaboration these precision instruments are fine-tuned and developed further. The product range is specialized in three areas – plastic surgery, orthopedics and classic STILLE instruments for various other surgical disciplines. True craftsmanship, outstanding performance and superior quality are the unique characteristics that make STILLE the hands down choice of surgeons worldwide.



Surgical Perfection

#### STILLE AB

Ekbacken 11  
SE-644 30 Torshälla, Sweden  
Phone: +46 8 588 580 00  
Fax: +46 8 588 580 05  
info@stille.se

[www.stille.se](http://www.stille.se)

#### Stille Surgical Inc.

915 Parkview Blvd  
Lombard, IL 60148  
United States  
Phone: 1.800.6651614

#### Distributed by: